

linkD

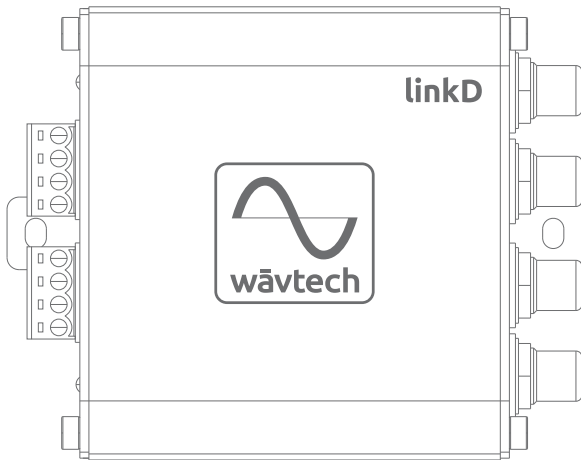

2-Channel LOC / Line Driver

10Vrms Output • Auto Turn-On • OEM Load Detect Compatible

Owner's Manual



www.wavtech-usa.com

 WARNING	This symbol means important instructions. Failure to heed them can result in serious injury or death.
 CAUTION	This symbol means important instructions. Failure to heed them can result in injury or property damages.

WARNING

- **DO NOT DRIVE WHILE DISTRACTED.** Any function that requires your prolonged attention should not be performed while driving. Always stop the vehicle in a safe location before performing any such function. Failure to do so may result in an accident.
- **KEEP THE VOLUME AT MODERATE LEVELS WHILE DRIVING.** Excess volume levels can obscure sounds such as emergency vehicle sirens or road warning signals and may result in an accident. Continuous exposure to high sound pressure levels may cause permanent hearing loss. Use common sense and practice safe sound.
- **FOR USE WITH 12V NEGATIVE GROUND VEHICLE APPLICATIONS ONLY.** Using this product other than in its designed application may result in fire, injury or product damage.
- **MAKE THE CORRECT WIRING CONNECTIONS AND USE PROPER FUSE PROTECTION.** Failure to connect wiring correctly or use appropriate fuse protection may result in fire, injury or product damage. Ensure proper fusing of all system power wiring and install a 1-ampere in-line fuse (not included) with the +12V lead to the unit's power supply connector.
- **DISCONNECT THE NEGATIVE BATTERY TERMINAL BEFORE INSTALLATION.** Failure to do so may result in fire, injury or damage to the unit.
- **DO NOT ALLOW CABLES TO BECOME ENTANGLED IN SURROUNDING OBJECTS.** Arrange wiring and cables to prevent obstructions when driving. Cables or wiring that obstruct or hang up on places such as steering wheel, brake pedals, etc. can be extremely hazardous.
- **DO NOT DAMAGE VEHICLE SYSTEMS OR WIRING WHEN DRILLING HOLES.** When drilling holes in the chassis for installation, take precautions so as not to contact, puncture or obstruct brake lines, fuel lines, fuel tanks, electrical wiring, etc. Failure to take such precautions may result in fire or an accident.
- **DO NOT UTILIZE OR CONNECT TO ANY PART OF VEHICLE SAFETY SYSTEMS.** Bolts, nuts or wires used in the brake, airbag, steering or any other safety-related systems or fuel tanks should NEVER be used for mounting, power or ground connections. Using such parts may disable control of the vehicle or result in fire.

CAUTION

- **STOP USE IMMEDIATELY IF A PROBLEM OCCURS.** Failure to do so may result in personal injury or damage to the product. Return it to your authorized Wävttech dealer.
- **HAVE AN EXPERT DO THE WIRING AND INSTALLATION.** This unit requires special technical skill and experience for wiring and installation. To insure safety and proper function, always contact the authorized dealer where you purchased the product to have it done professionally.
- **INSTALL THE UNIT SECURELY WITH SPECIFIED PARTS.** Be sure to use only the included parts and specified installation accessories (not included). Use of other than designated parts may damage this unit. Install the unit securely so that it will not come loose during a collision or sudden jolt.
- **ROUTE WIRING AWAY FROM SHARP EDGES AND MOVING PARTS.** Arrange cables and wiring away from sharp or pointed edges and avoid moving parts such as seat hinges or rails to prevent pinching or wear. Use loom protection where appropriate and always use a grommet for any wiring routed through metal.
- **NEVER RUN SYSTEM WIRING OUTSIDE OR UNDERNEATH THE VEHICLE.** All wiring must be routed, secured and protected inside the vehicle. Failure to do so may result in fire, injury or property damage.
- **INSTALL THE UNIT IN A DRY AND VENTILATED LOCATION.** Avoid mounting locations where the unit will likely be exposed to high moisture or heat without adequate ventilation. Moisture penetration or heat buildup may result in product failure.
- **REDUCE GAIN AND SOURCE VOLUME TO MINIMUM LEVELS FOR INITIAL SYSTEM TUNING AND BEFORE CONNECTION TO AN AMPLIFIER.** Ensure amplifier power is off before connecting RCA cables and follow proper system gain setting procedures. Failure to do so may result in damage to the amplifier and/or connected components.

Package Contents:

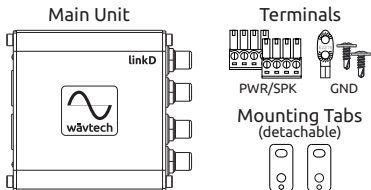

Accessories Required for Installation (not included):

- RCA Interconnects
- 18AWG Wire
- In-line Fuse Holder w/1A Fuse
- Battery Ring Terminal
- Wire Crimp Connectors
- Grommets and Loom
- Cable Ties
- Mounting Screws

Introduction

Welcome to Wävtech, exceptional mobile audio integration products for audiophiles. Our products are engineered to provide a truly remarkable listening experience. Built for the professional installer, our OEM integration and signal processor models are simply the best solution available for unlimited sound system upgrades while retaining the factory receiver.

Features

- 2-Channel Line Output Converter or Line Driver
- Differential Balanced Inputs
- Low Impedance Outputs
- Variable Gain Adjustment w/Clip LED
- Auto Turn-On via DC-Offset or Audio Signal Detect
- Generated +12V Remote Output
- OEM Load Detect Compatible
- Selectable Ground Isolation
- Locking Detachable Power/Speaker Terminals
- Panel Mount RCA Jacks
- Compact Aluminum Chassis w/Detachable Mounting Tabs

Connections & Functions

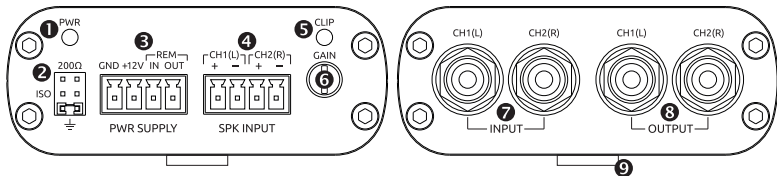

- 1 Power Indicator:** This red LED indicates when the linkD is powered on. Once illuminated, there will be a short delay before audio signal output is enabled. During initial power connections, the LED may illuminate for a brief period.
- 2 Ground Jumper:** For selecting between chassis, isolation or 200Ω for the internal audio signal ground. Chassis ground is the default setting and ideal for most applications due to the differential input stage. In the rare case there is system noise present after all other installation countermeasures, changing this jumper to ISO or 200Ω may reduce or eliminate the noise.

- ③ **Power Supply Terminal:** For +12V battery, chassis ground, remote in and remote output wire connections. A minimum of 18AWG wire is recommended for power and ground connections. Always protect the +12V power wire with a 1-amp fuse.
- ④ **Speaker Level Input Terminal:** For left and right channel speaker level (a.k.a. high level) connections to the source. Input signals ranging from 2Vrms to 20Vrms will produce up to 10Vrms RCA output from maximum to minimum gain. For factory amplifiers with more than 20Vrms signal or if the linkD's output is too high for the connected aftermarket amplifier(s) with all gains at minimum, internal jumpers are available to reduce the input sensitivity range by half (-6dB) for 4Vrms up to 40Vrms.
- ⑤ **Clipping Indicator:** This yellow LED indicates when the output signal is at maximum level before distortion (clipping) occurs. It will be dimly lit just before the onset of clipping, and full bright at clipping. If the connected amplifier(s) input can handle full 10Vrms output from the linkD, then the gain is set correctly when source unit is at its maximum unclipped volume and this LED is just starting to flicker. It is likely, however, that gain will need to be reduced to match your amplifier(s) maximum input capability or optimize source volume range.
- ⑥ **Gain Adjustment:** This adjustment is for matching the output signal level of the linkD with the maximum unclipped signal range provided by your source and the maximum input capability of your amplifier(s). Follow proper gain setting procedures to ensure optimum source volume range with minimum chance for clipping at any point in the signal chain. Aside from music, a 1kHz - 10dBfs signal tone may also be used for the tuning process to ensure proper headroom and gain overlap for typical music recording levels.
- ⑦ **RCA Input Jacks:** For left and right channel low level (a.k.a. line level) signal connections to the source unit. Input signals ranging from 0.5Vrms to 5Vrms will produce up to 10Vrms RCA output at maximum to minimum gain. These inputs are differential, but may be set to unbalanced via internal jumpers if necessary.
- ⑧ **RCA Output Jacks:** For left and right channel line level signal connections to your amplifier(s). Use quality interconnects to ensure stable connection and minimize the possibility for induced noise.
- ⑨ **Mounting Tabs:** These mounting tabs are pre-attached and should be used to properly secure the linkD during installation with screws or cable ties. They are removable if the unit can be safely secured by another method.

Installation & System Wiring

It is important to read this manual thoroughly before starting your installation and always plan accordingly. Before installing any Wāvtech product, disconnect the negative (ground) wire from the vehicle's battery to avoid damage to the vehicle or yourself. Following all guidelines will help provide years of enjoyment with your Wāvtech linkD audio interface.

Ground Connection (GND): The GND terminal must be connected to a metal part of the vehicle that is welded to the vehicle body with ground plane back to the main battery ground attachment point (a.k.a. chassis ground). This wire should be a minimum of 18AWG and as short as possible to minimize potential for noise to enter the system. The chassis ground connection point should have all of the paint removed and be scuffed to the bare metal. The ground wire should be terminated by a ground specific interlocking terminal such as the included EARL terminal or a ring terminal securely bolted to the vehicle with star or lock washer and nut to prevent from coming loose. Avoid using factory ground points to reduce the chance of induced noise from other components.

Power Connection (+12V): The constant power connection should be made at the vehicle battery when possible. For direct battery connection, a 1-amp fuse must be installed in-line with the power wire within 18" of the battery and securely connected to the positive battery terminal bolt with a ring terminal. If connecting to another available constant +12V power source, a 1-amp in-line fuse must be added at the connection point. The power wire should be a minimum of 18AWG. Do not install the fuse until all other system connections have been made.

Speaker Level Input (SPK): Connect the speaker wires from the source unit to corresponding terminals on the interface. Use the SPK input if your source unit is not equipped with RCA outputs. Always ensure the correct polarity of each channel when making these connections, as failure to do so can severely effect sound performance.

Remote Input (REM IN): If the source unit has a remote output wire (provides +12V only when turned on), connect it to the REM IN terminal. If a remote lead is unavailable, the linkD also has an auto turn-on circuit that simultaneously detects audio signal from SPK and AUX inputs as well as DC-offset from SPK inputs. While auto turn-on will work well in most applications, a +12V trigger may be required for satisfactory results under certain vehicle or system conditions. Additionally, DC-offset and/or audio signal detect functions can be independently defeated via internal jumpers (labeled DC and AUD) if necessary.

Remote Output (REM OUT): Use the remote output to provide a +12V trigger to turn on amplifiers or other aftermarket devices. This +12V output is generated internally by the interface when turned on either by REM IN or automatic sensing, and will provide over 500mA of continuous current for external devices.

System Examples

Example-1: Speaker Level Input from OEM Radio

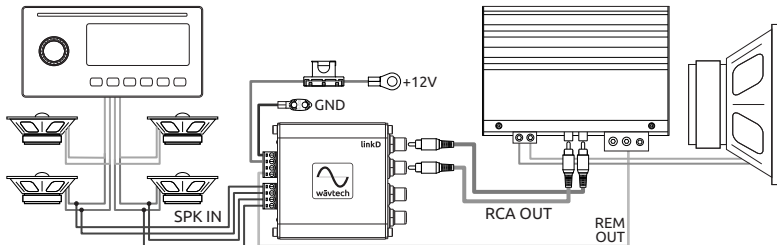

Note: When using a receiver's internal power IC to drive speakers directly and provide the linkD with signal, note that its speaker outputs will likely clip before reaching the maximum volume setting. Adjust gain settings accordingly for optimum unclipped volume range.

Example-2: Speaker Level Input from OEM Amplifier

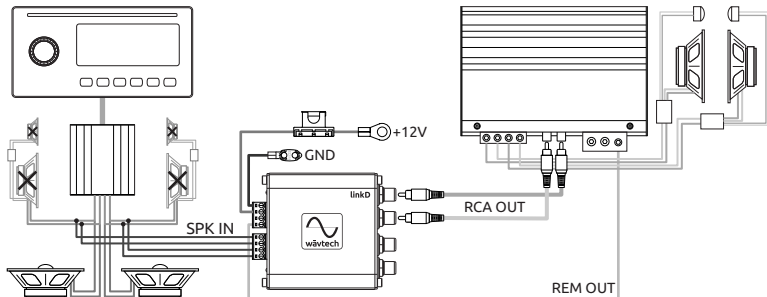

Note: In factory amplified systems where output from the radio is a fixed level or digital, input signal for the linkD should be connected at the OEM amplifier's outputs.

Example-3: RCA Input from Aftermarket Radio

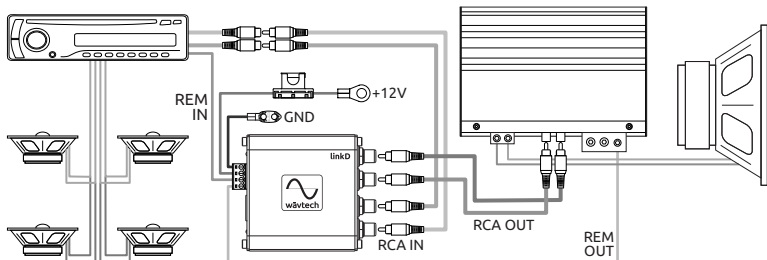

Note: When using a receiver's internal power IC to drive speakers directly and its RCA outputs to the linkD for external amplifiers, note that speaker outputs will usually clip at a lower volume level than RCA outputs. Adjust gain settings accordingly for matched unclipped volume range.

Example-4: RCA Input from Portable Audio Player

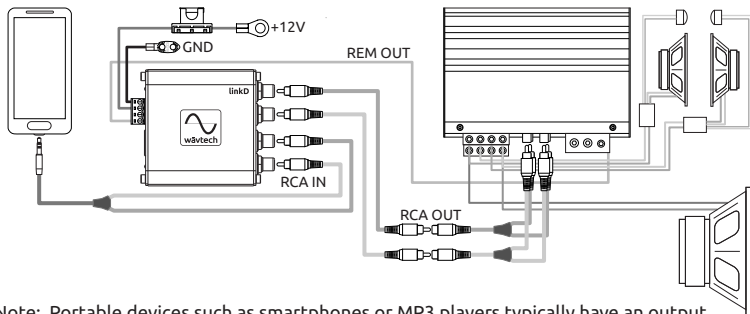

Note: Portable devices such as smartphones or MP3 players typically have an output voltage of 1Vrms or less. While the linkD's auto turn-on circuit will detect very low signal levels, in some cases the gain may need to be adjusted for reasonable listening levels but with reduced total volume range when using the device as the system's volume control.

Specifications

Frequency Response	Max Flat (+0/-1dB)		<10Hz to >75kHz
	Extended (+0/-3dB)		<10Hz to >100kHz
Input Impedance	Spk Input		180Ω
	RCA Input		20kΩ
Input Sensitivity	Spk Input (max-min gain)		2-20Vrms / 4-40Vrms
	RCA Input (max-min gain)		0.5-5Vrms
Max Input Voltage	Spk Input	peak, <5sec cont.	40Vrms
Output Impedance			<50Ω
Max Output Voltage	at 1% THD+N		>10Vrms
THD+N	Spk Input at 10V output		<0.1%
	RCA Input at 10V output		<0.01%
S/N	Spk Input	at 1V output	>95dBA
		at 4V output	>105dBA
		at 10V output	>112dBA
	RCA Input	at 1V output	>98dBA
		at 4V output	>110dBA
		at 10V output	>115dBA
Turn-On Trigger	Remote	via REM IN	>10.5V
	DC-offset	via Spk Input	>1.3V
	Audio Signal	via Spk Input	<100mV
		via RCA Input	<10mV
		Turn-off Delay	up to 60sec
Remote Output	Current Capacity		>500mA
	Voltage		Within 3% of B+
Current Draw	Max Draw (w/o REM OUT)		<200mA
	Sleep Current		<1mA
Operating Voltage	Power On (B+)		10.5V-18V
	Power Off (B+)		<8.5V
Product Dimensions	Chassis (not incl. terminals/jacks)		1.1"x2.9"x2.8"
			29x75x72mm

Notes:

- Speaker level input sensitivity range is selectable per channel via internal jumpers (20V/40V)
- DC-offset and/or audio signal detect functions are defeatable via internal jumpers (DC, AUD)
- All specifications are subject to change without notice

Installation Notes

Vehicle Description

- Year, Make, Model: _____
- Trim Level / Package: _____

OEM Audio System Info

- Head Unit (type, BT/AUX in, etc.): _____
- Speakers (size/location, etc.): _____

- Subwoofer(s) (size/location, etc.): _____
- Amplifier(s) (location, output voltage, etc.): _____

- Other: _____

linkD Connections & Settings

- Installed Location: _____
- Wiring (connection locations, signal type, turn-on mode, etc): _____

- Level Settings (gain position, max master vol, etc.): _____

- Other: _____

System Configuration: _____

Warranty & Service Care

Wävtech warrants this product to be free from defects in material and workmanship for a period of one (1) year when purchased from an authorized Wävtech retailer within the United States. This warranty will be extended to a period of two (2) years when the installation is performed by an authorized Wävtech retailer. A valid sales receipt is required to verify eligibility of purchase and installation.

This warranty is valid only to the original purchaser and is not transferrable to subsequent parties. This warranty is void if the product serial number has been altered or removed. Any applicable implied warranties are limited in duration to a period of express warranty as provided herein beginning with the date of the original purchase at retail, and no warranties, whether expressed or implied, shall apply to this product thereafter. Some states do not allow limitations on implied warranties, therefore these exclusions may not apply to you. This warranty gives you specific legal rights. You may also have other rights which vary from state to state.

If your product needs service, you should contact Wävtech Customer Service to receive a Return Authorization (RA) Number. Any product received without an RA number will be returned to sender. Once your product is received and inspected by customer service, Wävtech at its sole discretion, will be repair or replace it with a new or remanufactured product at no charge. Damage caused by the following is not covered under warranty: accident, abuse, failure to follow instructions, misuse, modification, neglect, unauthorized repair or water damage. This warranty does not cover incidental or consequential damages. This warranty does not cover the cost of removing or reinstalling the product. Cosmetic damage and normal wear are not covered under warranty.

For Service within the United States:

Wävtech Customer Service: (480) 454-7017
Monday – Friday, 8:30am to 5:00pm MST

Serial Number: _____

Installation Date: _____

Place of Purchase: _____

Important Notice for International Customers:

For products purchased outside the United States of America or its Territories, please contact your local distributor concerning specific procedures for your country's warranty policy. International purchases are not covered by Wävtech, LLC.

Wävtech®

7931 E. Pecos Rd

Suite 113

Mesa, AZ 85212

(480) 454-7017