

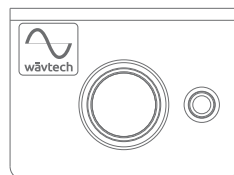
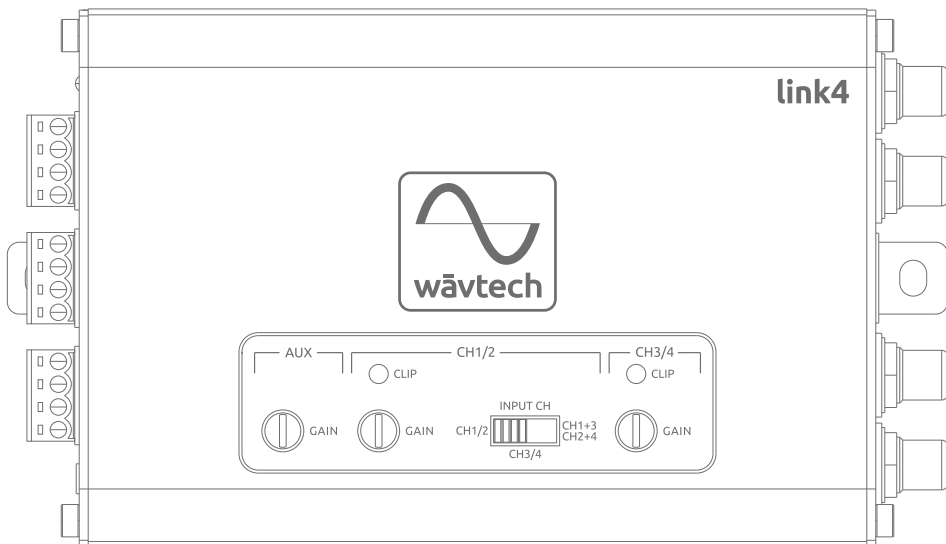

link4

4-Channel Line Output Converter

Summing • AUX Input • Multi-Function Remote

Owner's Manual



 WARNING	This symbol means important instructions. Failure to heed them can result in serious injury or death.
 CAUTION	This symbol means important instructions. Failure to heed them can result in injury or property damages.

WARNING

- **DO NOT DRIVE WHILE DISTRACTED.** Any function that requires your prolonged attention should not be performed while driving. Always stop the vehicle in a safe location before performing any such function. Failure to do so may result in an accident.
- **KEEP THE VOLUME AT MODERATE LEVELS WHILE DRIVING.** Excess volume levels can obscure sounds such as emergency vehicle sirens or road warning signals and may result in an accident. Continuous exposure to high sound pressure levels may cause permanent hearing loss. Use common sense and practice safe sound.
- **FOR USE WITH 12V NEGATIVE GROUND VEHICLE APPLICATIONS ONLY.** Using this product other than in its designed application may result in fire, injury or product damage.
- **MAKE THE CORRECT WIRING CONNECTIONS AND USE PROPER FUSE PROTECTION.** Failure to connect wiring correctly or use appropriate fuse protection may result in fire, injury or product damage. Ensure proper fusing of all system power wiring and install a 1-ampere in-line fuse (not included) with the +12V lead to the unit's power supply connector.
- **DISCONNECT THE NEGATIVE BATTERY TERMINAL BEFORE INSTALLATION.** Failure to do so may result in fire, injury or damage to the unit.
- **DO NOT ALLOW CABLES TO BECOME ENTANGLED IN SURROUNDING OBJECTS.** Arrange wiring and cables to prevent obstructions when driving. Cables or wiring that obstruct or hang up on places such as steering wheel, brake pedals, etc. can be extremely hazardous.
- **DO NOT DAMAGE VEHICLE SYSTEMS OR WIRING WHEN DRILLING HOLES.** When drilling holes in the chassis for installation, take precautions so as not to contact, puncture or obstruct brake lines, fuel lines, fuel tanks, electrical wiring, etc. Failure to take such precautions may result in fire or an accident.
- **DO NOT UTILIZE OR CONNECT TO ANY PART OF VEHICLE SAFETY SYSTEMS.** Bolts, nuts or wires used in the brake, airbag, steering or any other safety-related systems or fuel tanks should NEVER be used for mounting, power or ground connections. Using such parts may disable control of the vehicle or result in fire.

CAUTION

- **STOP USE IMMEDIATELY IF A PROBLEM OCCURS.** Failure to do so may result in personal injury or damage to the product. Return it to your authorized Wävtech dealer.
- **HAVE AN EXPERT DO THE WIRING AND INSTALLATION.** This unit requires special technical skill and experience for wiring and installation. To insure safety and proper function, always contact the authorized dealer where you purchased the product to have it done professionally.
- **INSTALL THE UNIT SECURELY WITH SPECIFIED PARTS.** Be sure to use only the included parts and specified installation accessories (not included). Use of other than designated parts may damage this unit. Install the unit securely so that it will not come loose during a collision or sudden jolt.
- **ROUTE WIRING AWAY FROM SHARP EDGES AND MOVING PARTS.** Arrange cables and wiring away from sharp or pointed edges and avoid moving parts such as seat hinges or rails to prevent pinching or wear. Use loom protection where appropriate and always use a grommet for any wiring routed through metal.
- **NEVER RUN SYSTEM WIRING OUTSIDE OR UNDERNEATH THE VEHICLE.** All wiring must be routed, secured and protected inside the vehicle. Failure to do so may result in fire, injury or property damage.
- **INSTALL THE UNIT IN A DRY AND VENTILATED LOCATION.** Avoid mounting locations where the unit will likely be exposed to high moisture or heat without adequate ventilation. Moisture penetration or heat buildup may result in product failure.
- **REDUCE GAIN AND SOURCE VOLUME TO MINIMUM LEVELS FOR INITIAL SYSTEM TUNING AND BEFORE CONNECTION TO AN AMPLIFIER.** Ensure amplifier power is off before connecting RCA cables and follow proper system gain setting procedure. Failure to do so may result in damage to the amplifier and/or connected components.

Package Contents:

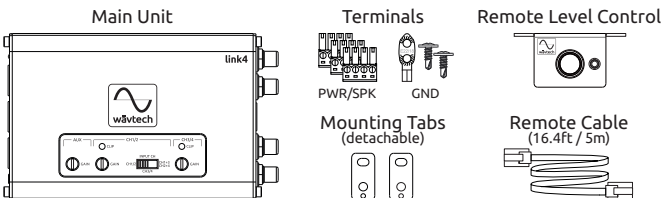

Accessories Required for Installation (not included):

- RCA Interconnects
- 18AWG Wire
- In-line Fuse Holder w/1A Fuse
- Battery Ring Terminal
- Wire Crimp Connectors
- Grommets and Loom
- Cable Ties
- Mounting Screws

Introduction

Welcome to Wävtch, exceptional mobile audio integration products for audiophiles. Our products are engineered to provide a truly remarkable listening experience. Built for the professional installer, our OEM integration and signal processor models are simply the best solution available for unlimited sound system upgrades while retaining the factory receiver.

Features

- 4-Channel Line Output Converter
- 4-Channel Summing Processor
- Multi-Function Remote (patent pending)
 - Master Volume Control
 - AUX Volume Control
 - Independent CH3/4 Level
 - Source/Function Select
- AUX 3.5mm Input
- Differential Balanced Inputs
- Low Impedance Outputs
- Variable Gain Adjustments w/Clip LEDs
- 2ch/4ch Input Select
- 2-Way Summing w/Retained CH3/4 Level Control
- Auto Turn-On via DC-Offset or Audio Signal Detect
- Generated +12V Remote Output
- OEM Load Detect Compatible
- Selectable Ground Isolation
- Locking Detachable Power/Speaker Terminals
- Panel Mount RCA Jacks
- Compact Aluminum Chassis w/Detachable Mounting Tabs

Connections & Functions

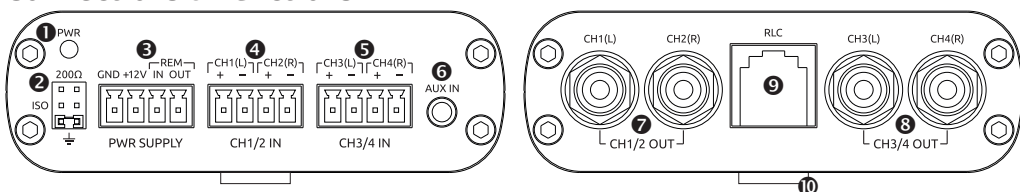

- 1 Power Indicator:** This red LED indicates when the link4 is powered on. Once illuminated, there will be a short delay before audio signal output is enabled. During initial power connection, the LED may illuminate for a brief period.
- 2 Ground Jumper:** For selecting between chassis, isolation or 200Ω for the internal audio signal ground. Chassis ground is the default setting and is ideal for most applications due to the differential input stage. In the rare case there is system noise present after all other installation countermeasures, changing this jumper to ISO or 200Ω may reduce or eliminate the noise.
- 3 Power Supply Terminal:** For +12V battery, chassis ground, remote input and remote output wire connections. A minimum of 18AWG wire is recommended for power and ground connections. Always protect the +12V power wire with a 1-amp fuse.
- 4 5 Speaker Level Input Terminals:** For up to four channels of speaker level (a.k.a. high level) input connections to the source. Input signals ranging from 2Vrms to 20Vrms will produce up to 10Vrms RCA output from maximum to minimum gain. For factory amplifiers with more than 20Vrms signal or if the link4's output is too high for the connected aftermarket amplifier(s) with all gains set at minimum, internal jumpers (labeled 20V/40V) are available to reduce the input sensitivity range by half (-6dB) for 4Vrms up to 40Vrms.
- 6 Auxiliary Input Jack:** This 3.5mm stereo AUX input is for the connection of a portable device such as a smartphone or MP3 player, but may also be used for other low level (a.k.a line level) sources using a 3.5mm adapter. AUX may be selected as a separate source via the multi-function remote, or programmed as the primary source for stand-alone systems where the speaker level inputs are not used (see pg4). Input signals ranging from 0.5Vrms to 5Vrms will produce up to 10Vrms RCA output from maximum to minimum gain. This input is differential but may be set to unbalanced via internal jumpers (labeled BAL/UNBAL) if required for a particular source.
- 7 8 RCA Output Jacks:** These four channels of RCA line level outputs are for signal connection to your amplifier(s). CH1/2's output will depend upon which INPUT CH setting is selected for CH1/2 (see pg3), while CH3/4 will always pass through its input signal directly. When selected, the AUX input will supply left/right stereo signals to both CH1/2 and CH3/4 outputs. Use quality interconnects to ensure stable connection and minimize the possibility for induced noise.
- 9 Remote Level Control Jack:** This RJ45 jack is for connecting the supplied cable to the external multi-function remote controller. A standard ethernet cable may also be used.
- 10 Mounting Tabs:** These mounting tabs are for securing the link4 during installation with screws or cable ties. They are removable if the unit can be safely secured by another method.

Top Panel Adjustments

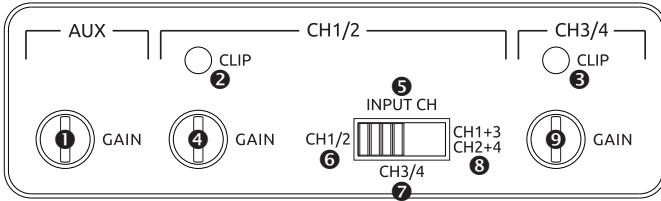

- 1 AUX Gain Adjustment:** In systems using both the link4's main speaker level and auxiliary inputs, this gain adjustment is primarily for matching the AUX output level with that of the main source. It is recommended to set the speaker level input gain(s) first, particularly if summing. For stand-alone systems using only the AUX input, use this gain adjustment to match the source's maximum unclipped signal output and connected amplifier(s) input capability. For portable devices such as smartphones or MP3 players, it is recommended to use the multi-function remote as the master system volume control and leave the device at its maximum clean volume setting.
- 2 3 Clipping Indicators:** These yellow LEDs indicate when the signal output from either CH1/2 or CH3/4 is at maximum level before clipping (distortion) occurs, whether the source is main speaker level or AUX input. Each will be dimly lit just before the onset of clipping, and full bright at clipping. Since the link4 can produce up to 10Vrms output before clipping, it is likely that gain(s) will need to be reduced below the illumination point(s) to match your amplifier(s) maximum input capability or optimize source volume range. Note that the AUX input is controlled by its own unified gain that affects all four output channel pairs equally and will illuminate all LEDs simultaneously when clipping.
- 4 CH1/2 Gain Adjustment:** This gain adjustment is for matching CH1/2's output signal level with the source's maximum unclipped signal range and the maximum input capability of connected amplifier(s). When a 4-channel speaker level source is connected, CH1/2's gain adjustment should be used for matching output level with that set for CH3/4, particularly when CH1+3/2+4 summed input is selected. If CH1/2 direct signal input is selected, adjust for any desired gain differences at the link4 while also minimizing amplifier gain settings for best S/N. Note that this gain adjustment will be bypassed if input select is set to CH3/4 copy.
- 5 CH1/2 Input Select:** This 3-position switch is for selecting which signal is routed internally to CH1/2's output stage. It provides for 2-channel, 4-channel or summed input as follows:

 - 6 CH1/2 (Direct):** For systems with a 4-channel speaker level source connected at the input terminals, this setting routes the signal input at CH1/2 directly to its gain and output stages.
 - 7 CH3/4 (Copy):** This setting is for systems where only a 2-channel speaker level source is available and is connected at CH3/4's input terminal. When selected, the internal signal after CH3/4's gain stage is copied to CH1/2's output stage. This bypasses CH1/2's gain so all four output channels are controlled together by CH3/4's gain adjustment. If independent gain is desired for CH1/2's output, use jumper wires at the input terminals and select CH1/2 direct input instead.
 - 8 CH1+3/2+4 (Sum):** Selecting this setting will sum CH1+CH3 (left) and CH2+CH4 (right) input signals after their gain stages and route them to their respective CH1(left) and CH2 (right) outputs. For vehicles without an available full-range signal, this setting can be used to sum pre-filtered signals together to create a useable full-range output. When a 4-channel full-range source is available, this setting may also be used to ensure CH1/2's output will always retain at least half signal, regardless of the source unit's fader position.

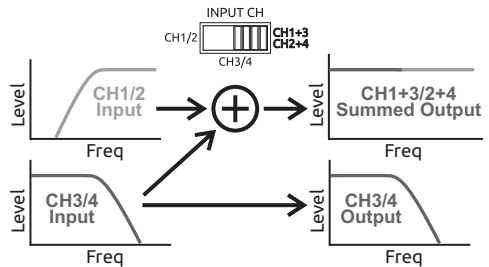

Multi-Function Remote

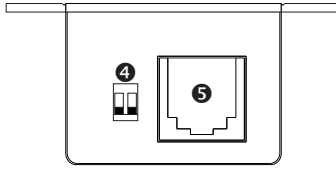
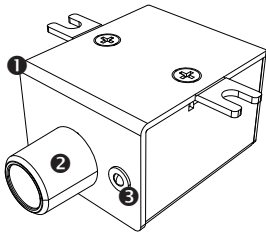

- 1 Remote Housing:** This 2-piece housing design provides both convenient mounting and simple disassembly for customization. The integrated screw mount tabs are scored to aid removal if securing by another method and the lower housing can be detached by removing the two top screws for reducing weight or size. For panel mounting, the housing can be completely disassembled by also removing the knob, shaft nut, and circuit board screw. It is recommended to protect the exposed PCB with heat shrink. For LED relocation, carefully release the LED from the back side of the snap ring, then push the snap ring through to the front to remove. Follow the reverse process for re-mounting.
- 2 Rotary Encoder:** This control knob is for adjusting CH1/2/3/4 master volume, CH3/4 level and source selection (toggle). The factory setting for knob function is CH3/4 output level adjustment only for a speaker level source. Other knob functions can be enabled via the dip-switches at the back of the remote (see 4 below). To toggle between Main and AUX sources, short-press the knob. To activate the selected source's CH3/4 level mode, long-press for 2-3 seconds. To reset to factory defaults for the selected system type, long-press the knob for >5 seconds.
- 3 Source/Function LED:** Depending upon which system type is selected (see 4 below), this LED will indicate which source and level mode is currently selected. There are four LED modes: solid red, flashing red, solid blue and flashing blue. In the default system Type-1, the only LED indication is solid red when the link4 is powered on. For the other three system types, solid red indicates Main speaker level source is selected and solid blue is for AUX source. Flashing indicates CH3/4 level mode is active for the current source, which will timeout after 5 seconds if no adjustments are made.
- 4 System Type Select:** These dip-switches are for selecting one of four available system types for setting which knob functions and priority are enabled. Note that the up/down position for each switch is when looking at the back of the remote as shown above. Switch settings can be changed at any time on the remote without requiring access to the main link4 unit.
 - Type-1: Main CH3/4 Level Only (factory setting)**
For systems where only subwoofer level control is needed with a speaker level source, and no AUX source is connected to the link4. In this setting, the knob's short-press and long-press functions (except reset) are disabled to prevent accidental selection.
 - Type-2: Main CH3/4 Level, AUX Volume & AUX CH3/4 Level**
For systems using the factory radio as the master volume for Main speaker level input and an auxiliary source is connected to the link4's AUX input. When Main source is selected, the knob adjusts CH3/4 level only. When AUX source is selected, knob priority is AUX volume and its CH3/4 level mode can be selected with a 2sec long-press.
 - Type-3: AUX Volume & AUX CH3/4 Level**
For stand-alone applications without a factory radio where only the link4's AUX input is used as the system source. In this setting, AUX CH3/4 level mode can be accessed with a 2sec long-press, while short-press for source select is disabled so cannot be accidentally changed.
 - Type-4: Master Volume & CH3/4 Level**
This setting is primarily for systems where factory radio volume is not used (e.g. fixed input signal level, volume dependent EQ, etc.), and that may also have an AUX source connected to the link4. In system Type-4, all knob functions are enabled. When either Main or AUX input is selected, knob priority is master volume for that source. Independent CH3/4 level adjustment is also accessible for each source with a 2sec long-press.
- 5 Remote Level Control Jack:** This RJ45 jack is for connecting the remote to the RLC port on the main link4 unit with the supplied cable. A standard 8-conductor ethernet cable may also be used.

Note: The link4 will remember all level settings and which source was selected at last power off and return at next power on, even if the battery is disconnected. However, if the remote is disconnected at power on, the memory will be overridden to factory defaults and all levels will return to maximum 0dB.

Installation & System Wiring

It is important to read this manual thoroughly before starting your installation and always plan accordingly. Before installing any Wävttech product, disconnect the negative (ground) wire from the vehicle's battery to avoid damage to the vehicle or yourself. Following all guidelines will help provide years of enjoyment with your Wävttech link4 audio interface.

Ground Connection (GND): The GND terminal must be connected to a metal part of the vehicle that is welded to the vehicle body with ground plane back to the main battery ground attachment point (a.k.a. chassis ground). This wire should be a minimum of 18AWG and as short as possible to minimize potential for noise to enter the system. The chassis ground connection point should have all of the paint removed and be scuffed to the bare metal. The ground wire should be terminated by a ground specific interlocking terminal such as the included EARL terminal or a ring terminal securely bolted to the vehicle with star or lock washer and nut to prevent from coming loose. Avoid using factory ground points to reduce the chance of induced noise from other components.

Power Connection (+12V): The constant power connection should be made at the vehicle battery when possible. For direct battery connection, a 1-amp fuse must be installed in-line with the power wire within 18" of the battery and securely connected to the positive battery terminal bolt with a ring terminal. If connecting to another available constant +12V power source, a 1-amp in-line fuse must be added at the connection point. The power wire should be a minimum of 18AWG. Do not install the fuse until all other system connections have been made.

Speaker Level Inputs (SPK): Connect the speaker wires from the source unit to corresponding input terminals at the interface. Always ensure correct polarity of each channel when making these connections, as failure to do so can severely effect sound performance.

Remote Input (REM IN): If the source unit has a remote output wire (provides +12V only when turned on), connect it to the REM IN terminal. If a remote lead is unavailable, the link4 also has an auto turn-on circuit that simultaneously detects audio signal from SPK and AUX inputs as well as DC-offset from SPK inputs. While auto turn-on will work well in most applications, a +12V trigger may be required for satisfactory results under certain vehicle or system conditions. Additionally, DC-offset and/or audio signal detect functions can be independently defeated via internal jumpers (labeled DC and AUD) if necessary.

Remote Output (REM OUT): Use the remote output to provide a +12V trigger to turn on amplifiers or other components. This +12V output is generated internally by the interface when turned on either by REM IN or automatic sensing, and will provide over 500mA continuous current for external devices.

Auxiliary Input (AUX): Connect the auxiliary low level source to the 3.5mm AUX input jack with a quality 3-conductor stereo 3.5mm audio cable. If the source has RCA outputs, an adapter will be required. Ensure the audio cable is routed away from power wires to minimize potential for induced noise.

Remote Level Control (RLC): Connect the multi-function remote to the link4's RLC port with the supplied 16.4ft/5m cable. Plan cable routing before mounting the remote to ensure proper length. If additional length is required, a standard 8-conductor CAT5 or CAT6 ethernet cable or extension may be used. The cable may also be shortened and re-terminated with a RJ45 connector and ethernet crimping tool.

System Examples

Example-1: Factory Radio (4-in/4-out)

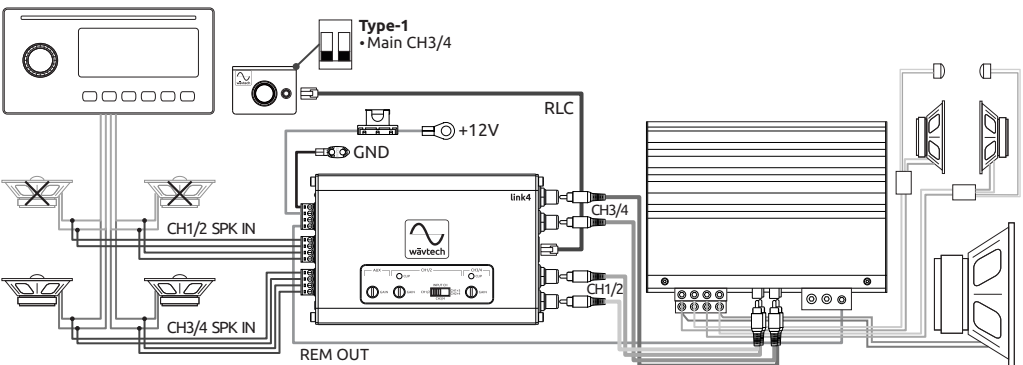

Note: For systems where only remote sub level control is needed for a speaker level source, select system Type-1 (factory setting) at the multi-function remote. If only a 2-channel signal is readily available, connect it to the CH3/4 SPK input terminal and set CH1/2's input select to CH3/4 copy, or use jumper wires and set to CH1/2 direct if independent CH1/2 gain is desired. When using the factory radio's internal power IC to drive speakers directly and supply the link4 with signal, note that its speaker outputs will likely clip at different levels and below the source unit's maximum volume setting. Adjust gain settings accordingly for optimum unclipped volume range.

Example-2: Factory Radio (2-in/4-out) with AUX

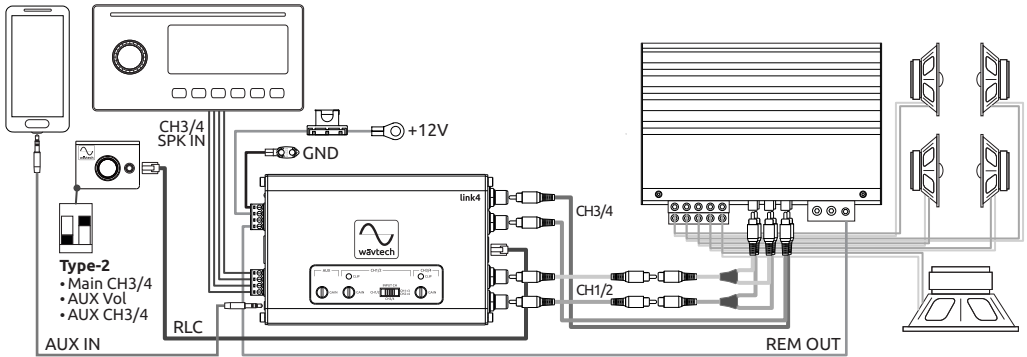

Note: For systems with a main speaker level source and an auxiliary source, select system Type-2 at the multi-function remote. This provides master volume control for AUX input as well as independent CH3/4 level adjustment for both sources. In this 5-channel system example, note that the link4's CH1/2 output needs to be split with y-adapters for the amplifier's front/rear channels (unless it has an input select switch) in order to reserve CH3/4 for sub level control. Adjust for any desired gain difference between front and rear at the amplifier.

Example-3: Stand-Alone AUX

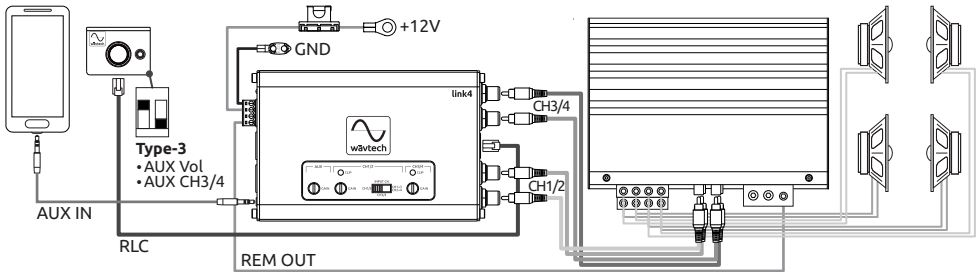

Note: For stand-alone systems where only the AUX input is used, select system Type-3 at the multi-function remote. This disables the remote's source select function and sets knob priority to master volume control for AUX input. In this front/rear full-range system example, CH3/4 level mode can be used to adjust rear level as needed. Portable devices such as smartphones or MP3 players typically have an output voltage of 1Vrms or less, so it is recommended to maximize the device's unclipped output level. Adjust AUX gain accordingly and use the remote as the system's master volume.

Example-4: Fixed Level Main Source (2-in/4-out) with AUX

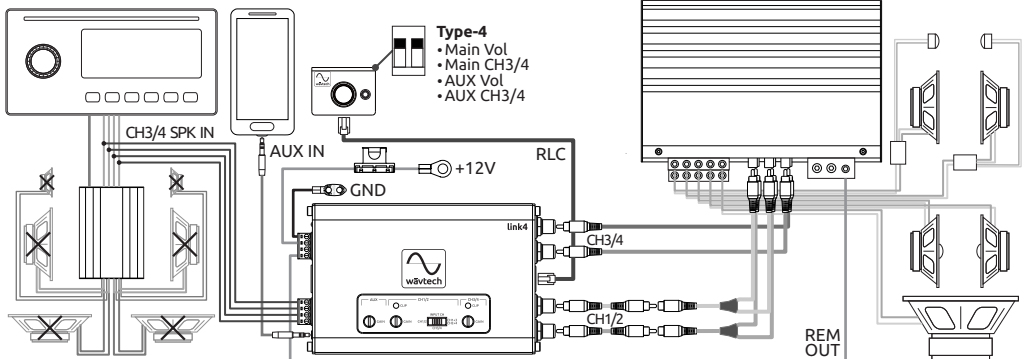

Notes:

- For factory amplified systems with non-defeatable effects such as volume dependent EQ or where the only clean signal available is a fixed level (e.g. volume control via CAN bus), select system Type-4 at the multi-function remote. This enables all remote Functions and sets knob priority to master volume control for both Main and AUX inputs. Independent CH3/4 level mode is also selectable for each source.
- Some fixed level or before-the-amp factory signals may actually be low level (e.g. less than 5Vrms) and not perform well when loaded down to speaker level impedances. To bypass the link4's built-in loading, remove the internal jumpers (labeled LOAD) located near the input terminal for each channel as needed.

Example-5: 2-way Summing (4-in/4-out) with AUX

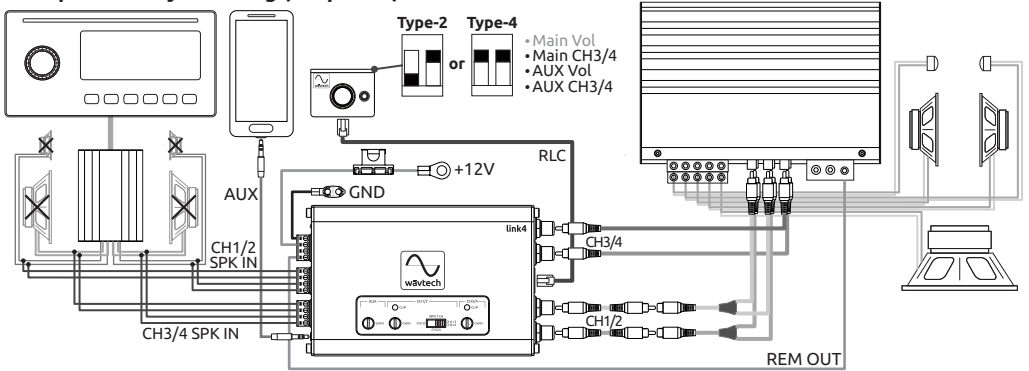

Notes:

- For factory systems without an available full-range signal, the Link4 can be used to sum 2-way signals together. When CH1+3/2+4 is selected for CH1/2's input, the summed left channel (CH1+3) and right channel (CH2+4) signals are routed to the CH1/2 outputs. Use CH1/2 and CH3/4 gains to match levels for as flat a frequency response as possible. Since CH3/4's input signal is always passed through to its output, it may also be useable depending upon its frequency response. In this system example, CH3/4's signal is factory low-passed for a front door mid-woofer that provides a useable low frequency response for a subwoofer and allows an appropriate LPF setting to be made at the amplifier. This configuration also retains use of the multi-function remote's CH3/4 level function as a sub level control.
- When both Main and AUX inputs are used, select either remote system Type-2 or Type-4 which provide source select and AUX volume functions. If master volume is required for Main input, select Type-4.

Example-6: 2-way Summing (4-in/2-out) and System Expansion

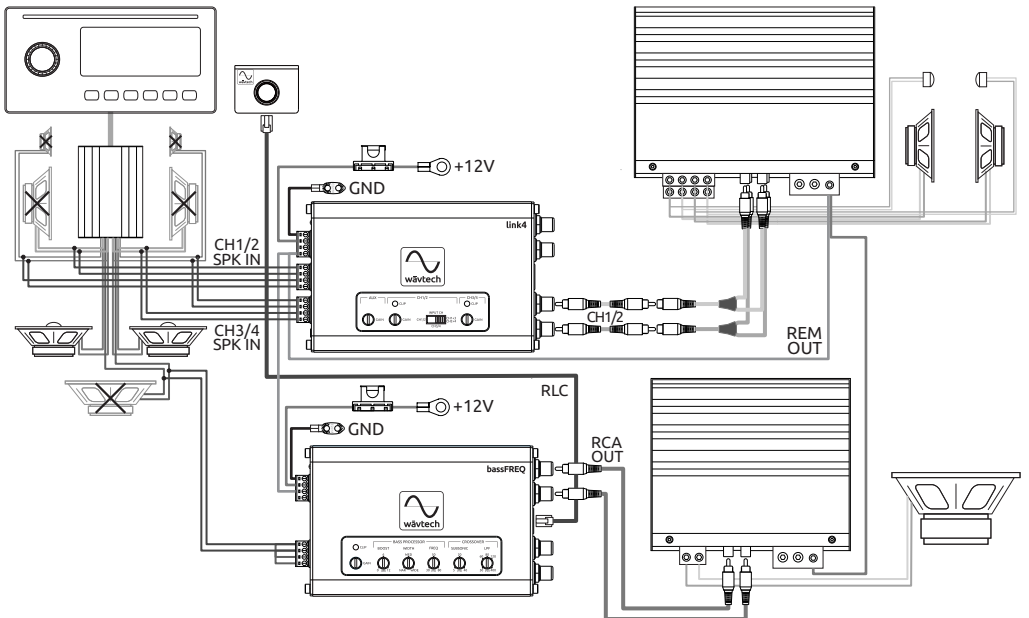

Notes:

- For systems where a full-range signal is not available for the desired channels such as front speakers for retaining fading capability from the factory radio, the link4 can be utilized purely as a 2-way summing line output converter without remote. This example shows the link4 summing the factory's front 2-way signals to full-range so crossover points can be altered at the aftermarket amplifier for a bi-amped component set. Depending upon frequency response of the factory channels tapped for the link4's CH3/4 input, its pass-through output may also be useable. If rear speakers are retained and/or powered by the factory amplifier, adjust gains accordingly for matched unclipped output and optimized system volume range.
- The link4 may also be used in conjunction with other Wavtech models for converting additional channels or adding features. In this system example, a bassFREQ provides additional signal conversion for a mono amplifier as well as remote sub level control, fully adjustable parametric EQ, variable -24dB/oct low-pass and subsonic filters.

Installation Notes

Vehicle Description

- Year, Make, Model: _____
- Trim Level / Package: _____

OEM Audio System Info

- Head Unit (type, BT/AUX in, etc.): _____
- Speakers (size/location, etc.): _____
- Subwoofer(s) (size/location, etc.): _____
- Amplifier(s) (location, output voltage, etc.): _____

- Other: _____

link4 Connections & Settings

- Installed Location: _____
- Wiring (connection locations, signal type, turn-on mode, etc.): _____

- Settings (gain, max master vol, crossover, etc.): _____

- Other: _____

System Configuration

System Diagram



Specifications

Frequency response	Max Flat (+0/-1dB)		<10Hz to >80kHz
	Extended (+0/-3dB)		<5Hz to >100kHz
Input Impedance	Spk Input		180Ω / 20kΩ
	AUX Input		>50kΩ
Input Sensitivity	Spk Input (max-min gain)		2-20Vrms / 4-40Vrms
	AUX Input (max-min gain)		0.5 - 5Vrms
Max Input Voltage	Spk Input	peak, <5sec cont.	40Vrms
Output Impedance			<50Ω
Max Output Voltage	at 1% THD+N		>10Vrms
THD+N	Spk Input at 10V output		<0.05%
	AUX Input at 10V output		<0.05%
S/N	Spk Input	at 1V output	>90dBA
		at 4V output	>106dBA
		at 10V output	>114dBA
	AUX Input	at 1V output	>93dBA
		at 4V output	>107dBA
		at 10V output	>115dBA
Remote Level Control	Master Volume Range		0dB to -50dB
	CH3/4 Level Range		0dB to -80dB
	CH3/4 vs. CH1/2 max Δ at min Vol		-30dB
	Knob Press Function	Source Select	<0.5sec
		CH3/4 Level	2-3sec (5sec timeout)
Reset		>5sec	
Turn-On Trigger	Remote	via REM IN	>10.5V
	DC-offset	via Spk Input	>1.3V
	Audio Signal	via Spk Input	<100mV
		via AUX Input	<10mV
		Turn-off Delay	up to 60sec
Remote Output	Current Capacity		>500mA
	Voltage		Within 3% of B+
Current Draw	Max Draw (w/o REM OUT)		<300mA
	Sleep Current		<2mA
Operating Voltage	Power On (B+)		10.5V-18V
	Power Off (B+)		<8.5V
Product Dimensions	Main Chassis (HxWxD not incl. terminals, jacks)		1.1"x3.5"x5.2"
			29x90x133mm
	Remote Housing (HxWxD not incl. knob, tabs)		1.1"x1.5"x1.8"
			28x38x45mm

Notes:

- Speaker level input sensitivity range is selectable per channel via internal jumpers (20V/40V)
- Built-in speaker level input loading is defeatable per channel via internal jumpers (LOAD)
- DC-offset and/or audio signal detect functions are defeatable via internal jumpers (DC, AUD)
- All specifications are subject to change without notice

Multi-Function Remote System Type Settings

Source	Knob Function	Type-1	Type-2	Type-3	Type-4
Main	Master Volume	—	—	—	✓
	CH3/4 Level	✓	✓	—	✓
AUX	Master Volume	—	✓	✓	✓
	CH3/4 Level	—	✓	✓	✓

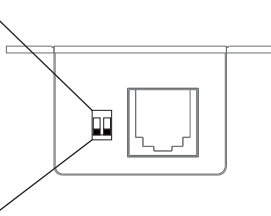

Warranty & Service Care

Wävtech warrants this product to be free from defects in material and workmanship for a period of one (1) year when purchased from an authorized Wävtech retailer within the United States. This warranty will be extended to a period of two (2) years when the installation is performed by an authorized Wävtech retailer. A valid sales receipt is required to verify eligibility of purchase and installation.

This warranty is valid only to the original purchaser and is not transferrable to subsequent parties. This warranty is void if the product serial number has been altered or removed. Any applicable implied warranties are limited in duration to a period of express warranty as provided herein beginning with the date of the original purchase at retail, and no warranties, whether expressed or implied, shall apply to this product thereafter. Some states do not allow limitations on implied warranties, therefore these exclusions may not apply to you. This warranty gives you specific legal rights. You may also have other rights which vary from state to state.

If your product needs service, you should contact Wävtech Customer Service to receive a Return Authorization (RA) Number. Any product received without an RA number will be returned to sender. Once your product is received and inspected by customer service, Wävtech at its sole discretion, will repair or replace it with a new or remanufactured product at no charge. Damage caused by the following is not covered under warranty: accident, abuse, failure to follow instructions, misuse, modification, neglect, unauthorized repair or water damage. This warranty does not cover incidental or consequential damages. This warranty does not cover the cost of removing or reinstalling the product. Cosmetic damage and normal wear are not covered under warranty.

For Service within the United States:

Wävtech Customer Service: (480) 454-7017
Monday – Friday, 8:30am to 5:00pm MST

Serial Number: _____
Installation Date: _____
Place of Purchase: _____

Important Notice for International Customers:

For products purchased outside the United States of America or its Territories, please contact your local distributor concerning specific procedures for your country's warranty policy. International purchases are not covered by Wävtech, LLC.

Wāvtech[®]

7931 E. Pecos Rd
Suite 113
Mesa, AZ 85212
(480) 454-7017