

Remote control functionality

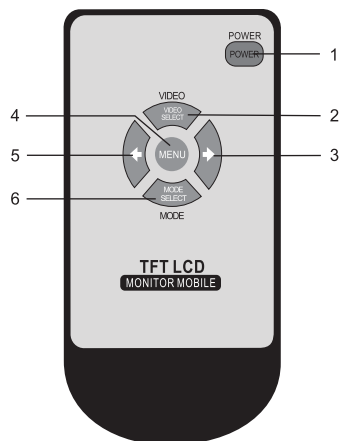

1. Power ON/Off
2. Camera Input Change
3. Right
4. Menu
5. Left
6. Mode selection

Technical assistance

If you need assistance setting up or using your Gator product now or in the future, call Gator Support.
Australia

TEL: 03 – 8587 8898

FAX: 03 – 8587 8866

Mon-Fri 9am – 5pm AEST

Please retain this user guide for future reference.

If you would like to download a digital copy of this manual, or other Gator manuals/software, please visit the <http://gatordriverassist.com> website and click on 'Firmware & Manuals' for information on where to find the manuals/software.

This manual is considered correct at time of printing but is subject to change. For latest manuals and updates refer to the website.

Copyright © 2017 by TDJ Australia

All rights reserved. No part of this publication may be reproduced, distributed, or transmitted in any form or by any means, including photocopying, recording, copying or other electronic or mechanical methods, without the prior written permission of the author.



www.gatordriverassist.com



GATOR

TRADE series

GT7050TK

7" Monitor Trailer Kit with Heavy Duty Cameras



3 YEAR WARRANTY

PRO LINK II



Before operating the Monitor, please read this manual thoroughly and retain it for future reference.

Inclusions

- 1 x Monitor
- 2 x CMOS cameras
- 1 x Power cable
- 1 x Wire harness
- 1 x Extension cable
- 1 x Trailer cable kit
- 1 x Sun shade
- 1 x U-bracket
- 4 x U-bracket screws
- 1 x Remote controller

Product structure

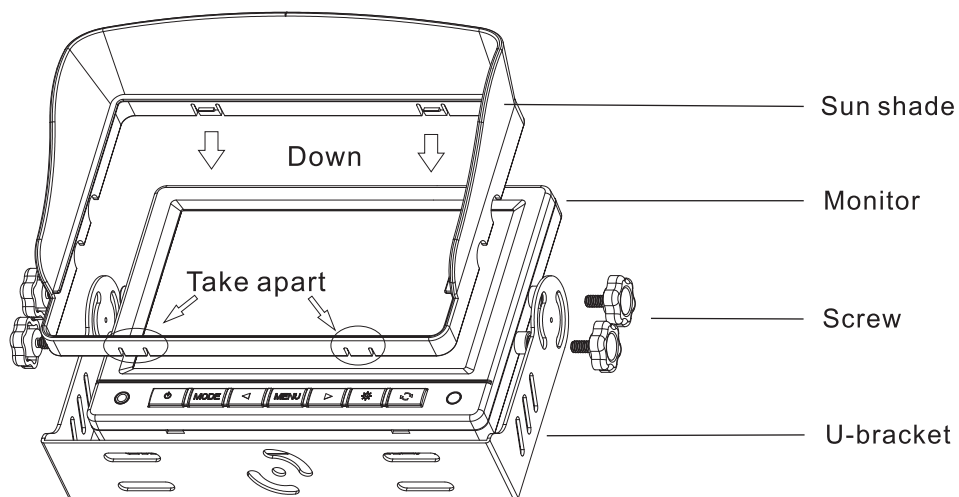

Monitor Features

- 7" Monitor
- Resolution 800x480 RGB
- Bright 350CD Display
- Aspect Ratio: 16:9
- 3X Video Inputs (2 Trigger)
- PAL/NTSC Auto Switching
- 6M Main Harness Cable, Trailer Cable Kit & 10M Prolink II Extension Cable
- Rear View Delay (0~15S selection)
- High/Low Voltage & Short Circuit Protection
- 12/24 Input Voltage
- Detachable Sunshade
- Supplies 12V Power to Cameras

Trailer Camera Features

- CMOS Image sensor
- 120 Degree Wide Angle Lens
- Rated *IP68* Waterproof
- Minimum Illumination: 0 Lux
- 10 IR LED's
- 1/4" Image Sensor

Car Camera Features

- CMOS Image sensor
- 120 Degree Wide Angle Lens
- Rated *IP67* Waterproof

Monitor functionality & settings

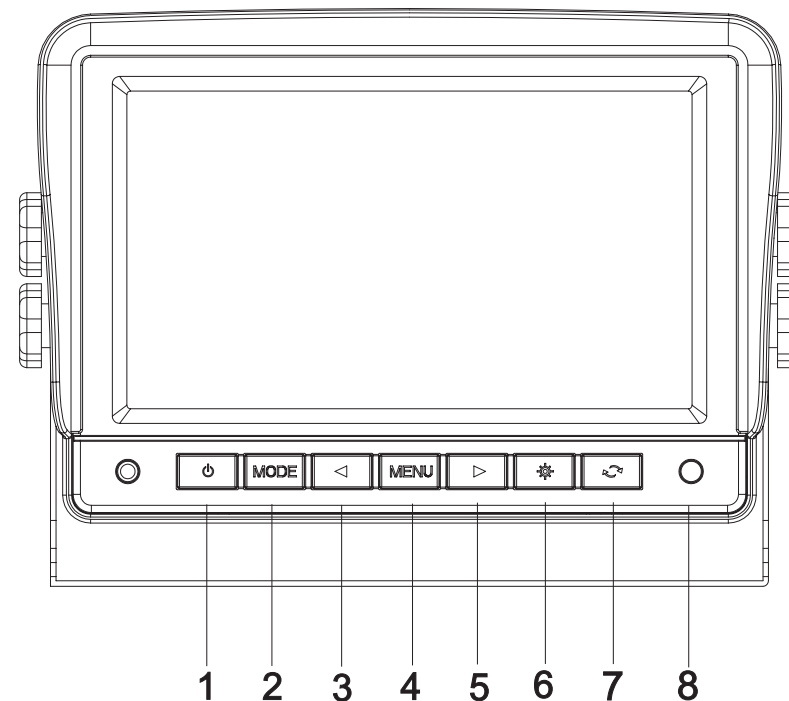

1. Power ON/Off
2. Camera input viewing modes.
3. Left
4. Menu
5. Right
6. Picture (Day, Night1, Night2, Night3, User)
7. Mirror
8. Remote sensor

Menu structure

Press the Menu button to scroll through each menu item.

When you see the menu item that you wish to change simply press the left or right arrow key to change it to the desired setting. The right arrow key increases the setting, the left arrow decreases the setting. To exit the menu system simply wait 4 seconds without pressing any buttons.

The menu structure is in the following sequence.

Brightness, Contrast, Colour, Aspect ratio (Mode) ,Language, Mirror, Back Delay, Guide line, Reset.

Menu item descriptions.

1. Brightness: Adjusts the brightness of the screen. Be careful not to adjust this setting to high as this will reduce the contrast (blacks will eventually become greys reducing the contrast to whites)

2. Contrast: Adjust the transitions of highlighted areas to darkest shadows. A higher contrast makes the image appear sharper, but too much contrast will remove subtle details in the mid tones.

NOTE: There is also a direct access button second from the right (Picture) at the base of the screen that adjusts the brightness and contrast to preset levels. This button toggles between settings of Day, Night1, Night2, Night3, and User settings.

3. Colour (Saturation): This adjusts the colour saturation. Higher levels yield more colour, however too much colour may affect night time performance (may result in a noisy image).

4. Mode: 16:9 or 4:3. The monitor has a 16:9 aspect ratio screen so if you select 4:3 it will result in a Black band on either side of the image by creating a square image. Depending on the camera's aspect ratio. This setting will correct aspect ratio misalignment where an image may be stretched or compressed.

NOTE: The mode setting is global and affects all cameras

5. Language: There are 9 different language settings including popular languages such as German, Chinese, Italian, and Spanish.

6. Mirror: Depending on the direction of the camera you may wish to change the left to right orientation of the image for each camera. An example of this function would be in the event you have a forward facing camera and a rear facing camera. One of these images is best viewed as a mirror image (the rear view) and the other as a normal view (the front facing camera). Another situation that may need to be addressed is a camera that already has a mirror flip that is unwanted (being used as forward facing) many cameras sold in today's market have a mirror flip built in.

NOTE: this setting only affects the currently viewed camera (not all cameras). To change the desired camera, you must be viewing the camera you want to change when entering the menu system)

NOTE 2: There is also a direct access button for this functionality at the bottom Right of the screen.

7. Back delay: This sets the Off delay time of the camera. When set, the monitor will remain on for the designated amount of seconds before switching off. This function is global so it affects all cameras.

8. Guide line: Sets Parking guide lines on or off for AV2 only. (AV1 the vehicle camera always has guidelines on).

NOTE: For AV2 guidelines. The guide lines only appear when the camera is triggered. If the camera is manually selected the guide lines do not appear.

9. Reset: Returns the unit to factory settings.

Common Trailer pin configurations (Always check your individual trailers wiring in case its not standard)

7 Pin Plug

Pin	Connection	Colour
1	Left Indicator	Yellow
2	Auxiliary or Reverse Light	Black
3	Earth	White
4	Right Indicator	Green
5	Electric Brakes	Blue
6	Stop Light	Red
7	Tail Lights	Brown

7 Pin Flat

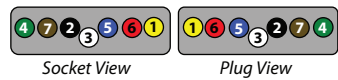

7 Pin Round

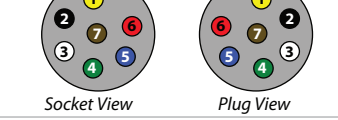

Extra for Flat 12 Pin Plug

Pin	Connection	Colour
8	Left Indicator	Orange
9	Auxiliary or Reverse Light	Pink
10	Earth	White
11	Right Indicator	Grey
12	Electric Brakes	Violet

12 Pin Flat

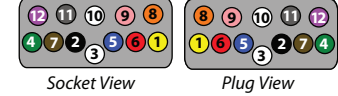

Trigger wire wiring

Fig1

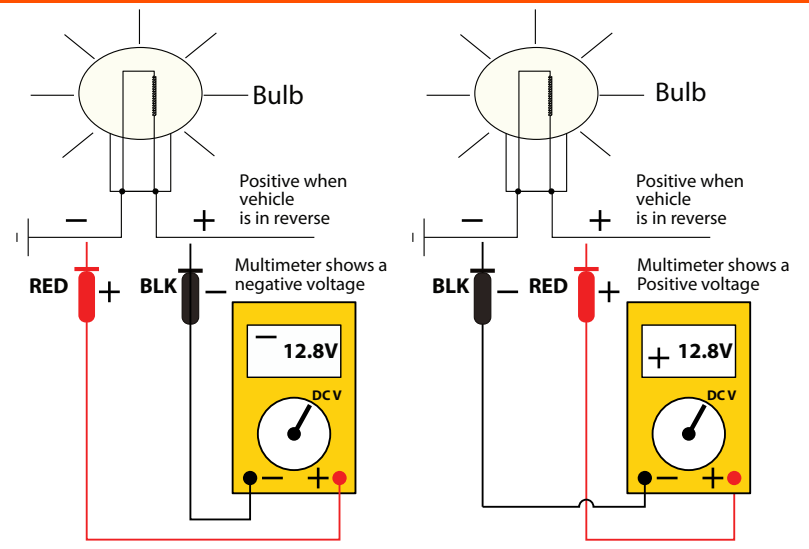

Trailer diagram with priority trigger

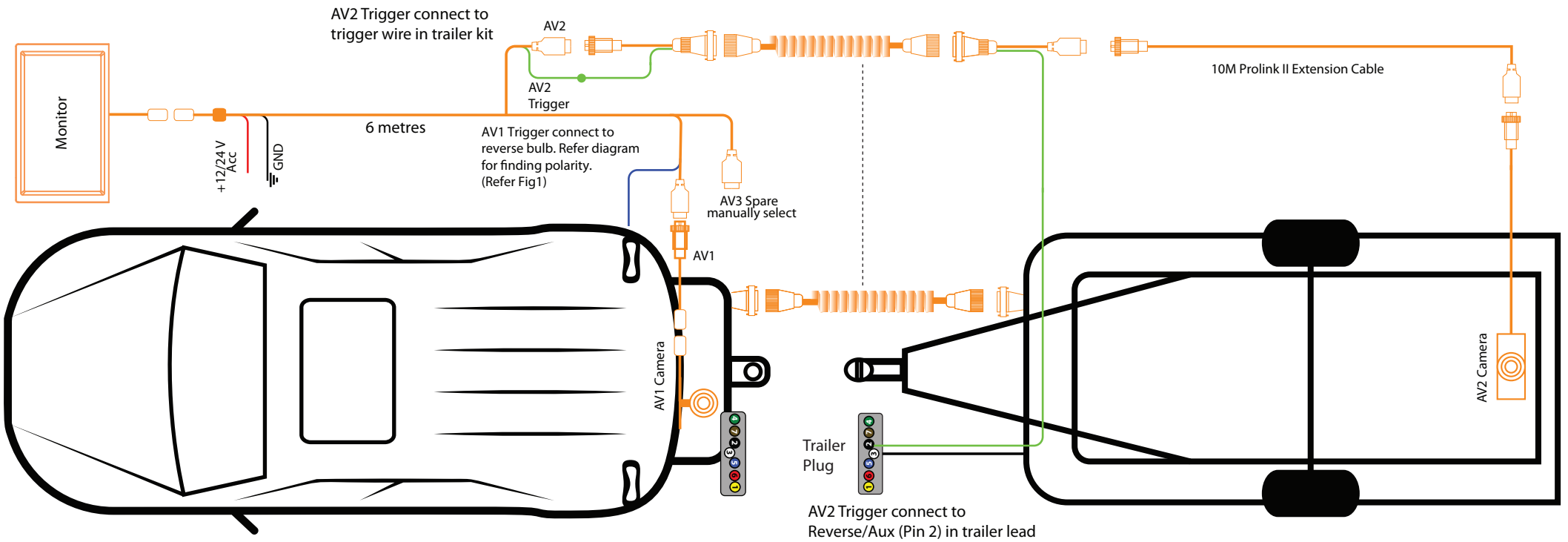

Available extension models: PLC5/PLC10/PLC15/PLC20
 *** Add on Camera Models: G354C (Used as AV1) Standard camera moves to AV2

Note: Always use AV2 for the trailer as it will take priority when connected. This will happen automatically as it is triggered when the cameras trailer kit is connected.

How to find reversing wires to trigger or power backup camera systems.

We recommend that you wire up the triggers as the last part of your installation (after the systems monitor has been wired) this is so that you can use the system as a safe way to test for a reversing wire.

Back up camera systems (reversing camera systems) require a signal to "Trigger" the system into action so that it automatically operates when the vehicle is in reverse.

Whilst some systems are designed to allow cameras to operate even when the vehicle is not in reverse it is still necessary to wire a trigger system in so that the Camera that is facing backward automatically turns and or takes over as priority when in the vehicle is in reverse. When wired in correctly using the right trigger priority, the system can also automatically turn on the rear camera of an attached trailer taking priority over the vehicles back up camera when the trailer is connected.

The most common way to trigger the rear facing camera is to use the + wire that powers one of the vehicles reversing globes at the back of the vehicle.

NOTE: Some vehicles that Use CAN bus to operate rear lighting systems may require additional parts to trigger the system.

Caution: Never test for reversing wires standing at the back of the vehicle, with the engine running and the gearbox in reverse gear. If the car/truck can not be placed in reverse without the engine running, Special procedures should be employed. In this case we highly recommend you seek a professional installer to do this type of work. Failure to follow proper procedure could cause serious injury or death. (The vehicle could back over you)

Step 1.

Place the car in reverse, with ignition on but the car not running (do not leave the cars ignition on for long periods of time without starting it) observe or have an observer notice which light turns on and its location in the lens. Turn the ignition off. Then, locate the globe socket that holds the reversing globe into the lens. In some cases the Lens has to be removed from the car to expose the socket. In most cases however, you can gain access from the inside of the car behind a removable interior wall/panel.

Step 2.

Identify which wire is the globes ground and which is positive (see Fig 1 diagram). Light globes have very low resistance so if a globe is in place, both wires will show up as a ground. Even if you remove the globe the second globe on the other side of the vehicle will still give the positive side a short path to ground and may still be indistinguishable from the globes earth. For this reason it is necessary to energize the globe to find out which side is positive and which side is negative.

Using a multimeter set to DC volts (make sure that it is on the correct scale) attach the negative probe to one of the globes wires and the positive probe to the other (in most cases you can push the probe ends into the back of the globe socket) if not, you may have to

carefully strip both wires sheaths back to expose the wires core making sure you keep them separate and away from the cars chassis to avoid any shorts). You should also make sure the globe itself is not resting on something that could be harmed by extreme heat as the globe when on can get very hot). Turn the ignition back on again with the cars gear set to reverse (without the engine running). The globe should illuminate and the multimeter will show a positive voltage or a negative voltage across the globe. By noting whether the voltage is positive or negative you can define which wire is positive or negative. If the reading is positive then the probes positive is connected to the positive wire. If it's a negative reading then the multimeter's negative probe is connected to the positive wire of the globe as a final check, take the vehicle out of reverse with the ignition still on and check that the voltage is now zero.

If the vehicle can not be placed in reverse without the engine running the following procedure should be used. With the car off, remove the globe. Set your multimeter to resistance on the lowest setting. Place one probe on a part of the chassis that is ground (most rear tail light assemblies have a small grounding screw close by). If you can not find one look for some exposed chassis (like a tailgate hinge etc). Measure the resistance to ground of both wires in the back of the globe socket (with the globe out) whilst the resistance will be very similar (because of the other globe still in the circuit) one wire will have a slightly higher resistance. The one with the highest resistance should be the positive wire.

Connect the system to this wire and then use the reversing system to test if it is triggering. With no one at the rear of the vehicle. Start the car. Make sure the reversing systems monitor is in the off state and then place the vehicle in reverse. If you have found the correct wire the system will automatically turn on from its off state. If you have connected the trigger to the globes earth no harm is caused but the system will not trigger. In that case simply connect it to the alternate wire and repeat.

CAN BUS

In the event that the cars reversing lights are driven by CAN BUS the above wiring system may not trigger the system correctly. It may even create a globe fault warning. In this case a CAN BUS module (sold separately) may need to be installed. However, just because the vehicle has a CAN BUS system does not necessarily mean that it will require such a module to work. In fact the opposite is true. Most vehicles do not require an additional module. If a CAN BUS module is required we recommend seeking advice from a professional installer.

Multi trigger systems. Please refer to the diagram provided with trailer trigger systems. Pay special attention to the AV camera numbers and trigger numbers. It is important that the AV camera numbers match the diagrams placement in order to provide the correct priorities so that when a trailer is connected it takes rear view priority over the vehicles rear view camera and so that when no trailer is connected the vehicles rear camera operates automatically.

GT70SDTK configurations

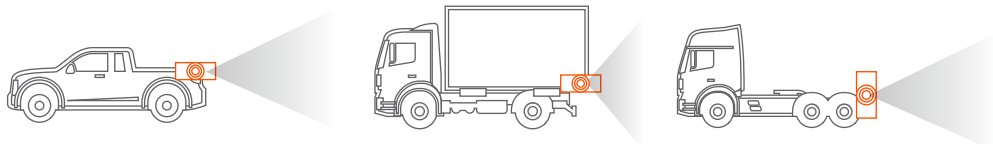

This system comes with one camera as illustrated above, however it is capable of running up to 3 cameras and can cover a very large array of vehicle requirements. The following diagrams show some additional (but not all), configurations that the system is capable of handling with the addition of some extra cameras and associated accessories. Please refer to our web site for detailed schematics of these installations.

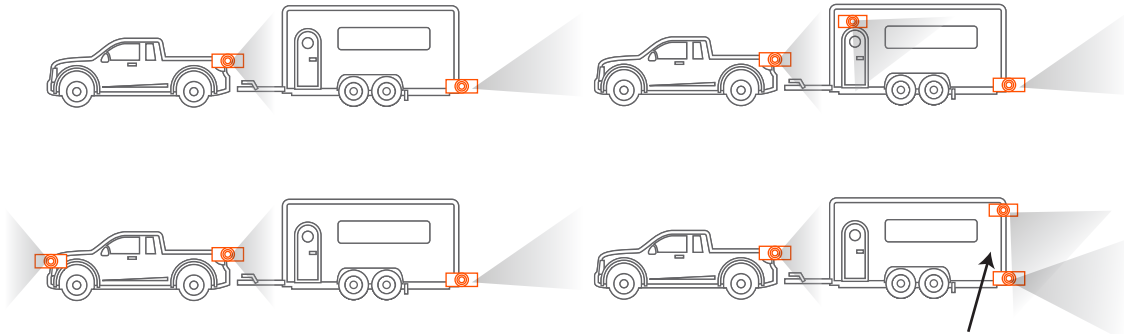

Having two cameras at the back, one camera can be optimised for parking (top down view) whilst the other can look backwards and be used as a rear-view mirror substitute.

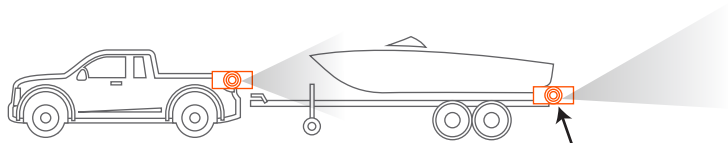

This camera can be used for reversing or as a rear-view mirror substitute

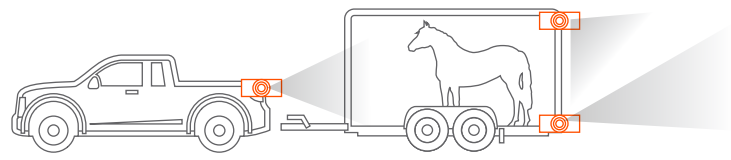
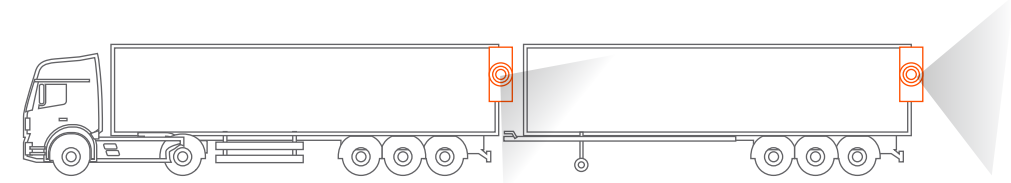
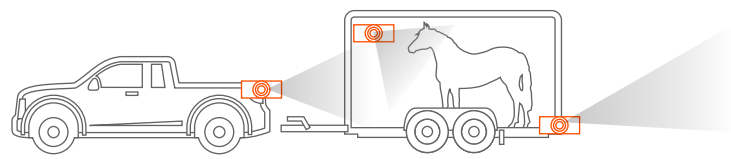
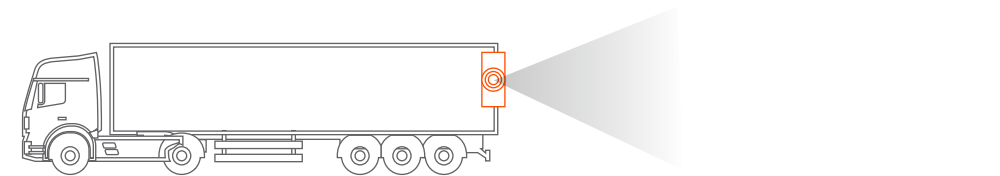
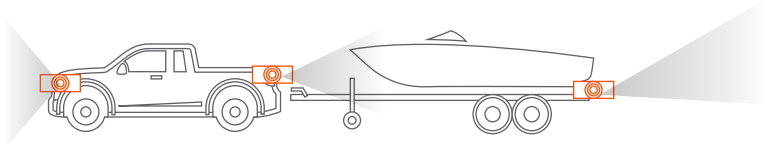

Having two cameras at the back, one camera can be optimised for parking (top down view) whilst the other can look backwards and be used as a rear-view mirror substitute.

Scan the QR code to go to our website. Click on the icon for a full schematic wiring diagram to suit your installation.
 Note: Additional cameras and wiring may be required depending on your application, compatible products are available on our website.

