



ADVANCED SAFETY **VISION SYSTEMS**

AVK5W1 5" WIRELESS HEAVY DUTY MONITOR
720P HD CAMERA KIT

USER MANUAL



Wireless

HD
720P

SINGLE
CAMERA INPUT

12/24V
COMPATIBLE

ADVANCED SAFETY **VISION SYSTEMS**

Product overview

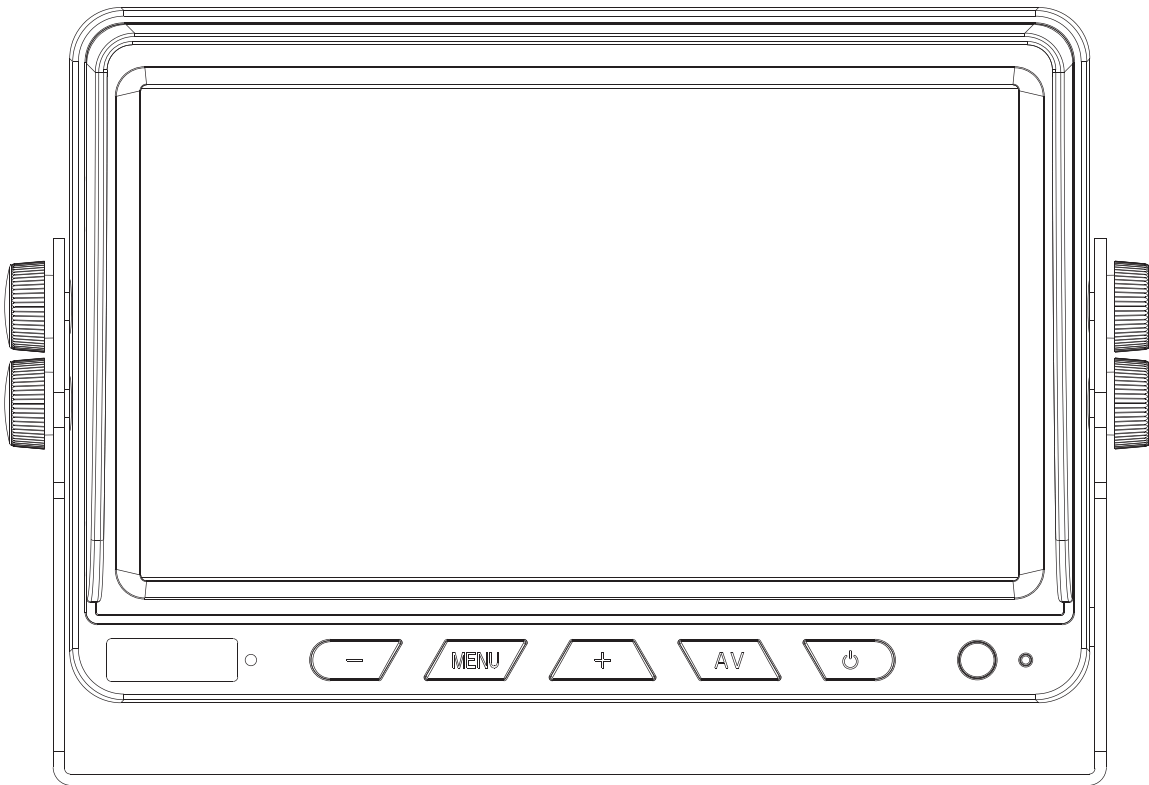

Bracket installation

1. Fix the U-bracket into position. Insert and lock the monitor into the bracket using the mounting screw knobs.

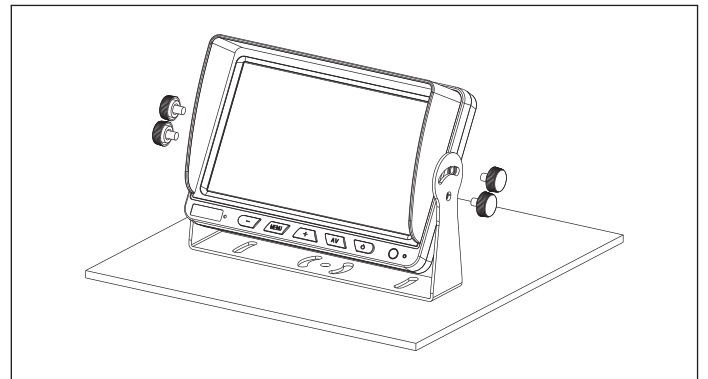
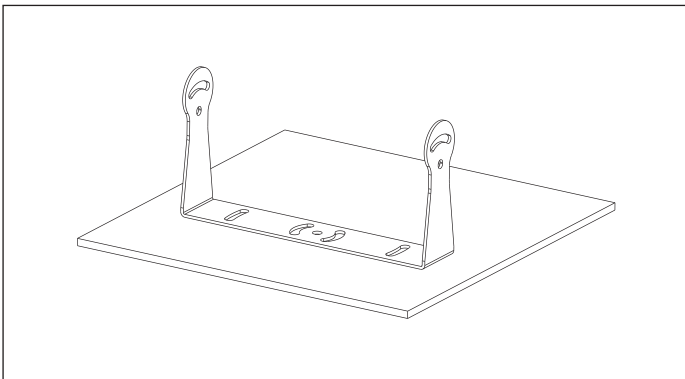

2. Adjust to your desired angle.

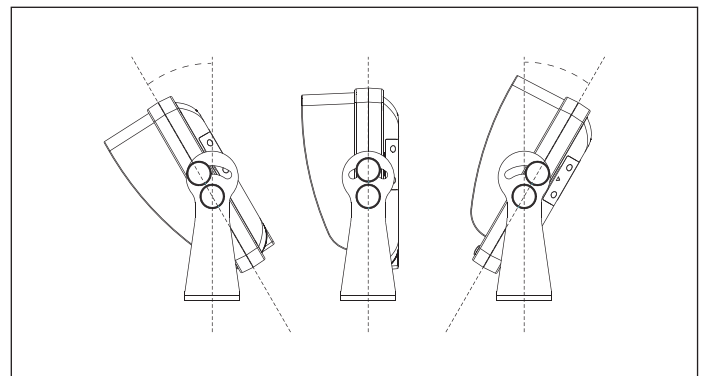
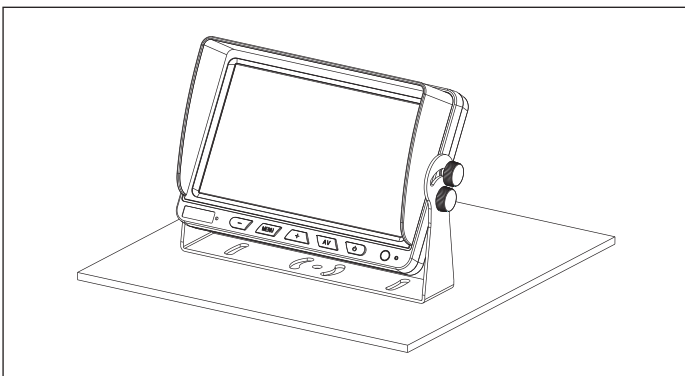

ADVANCED SAFETY **VISION SYSTEMS**

Installation options

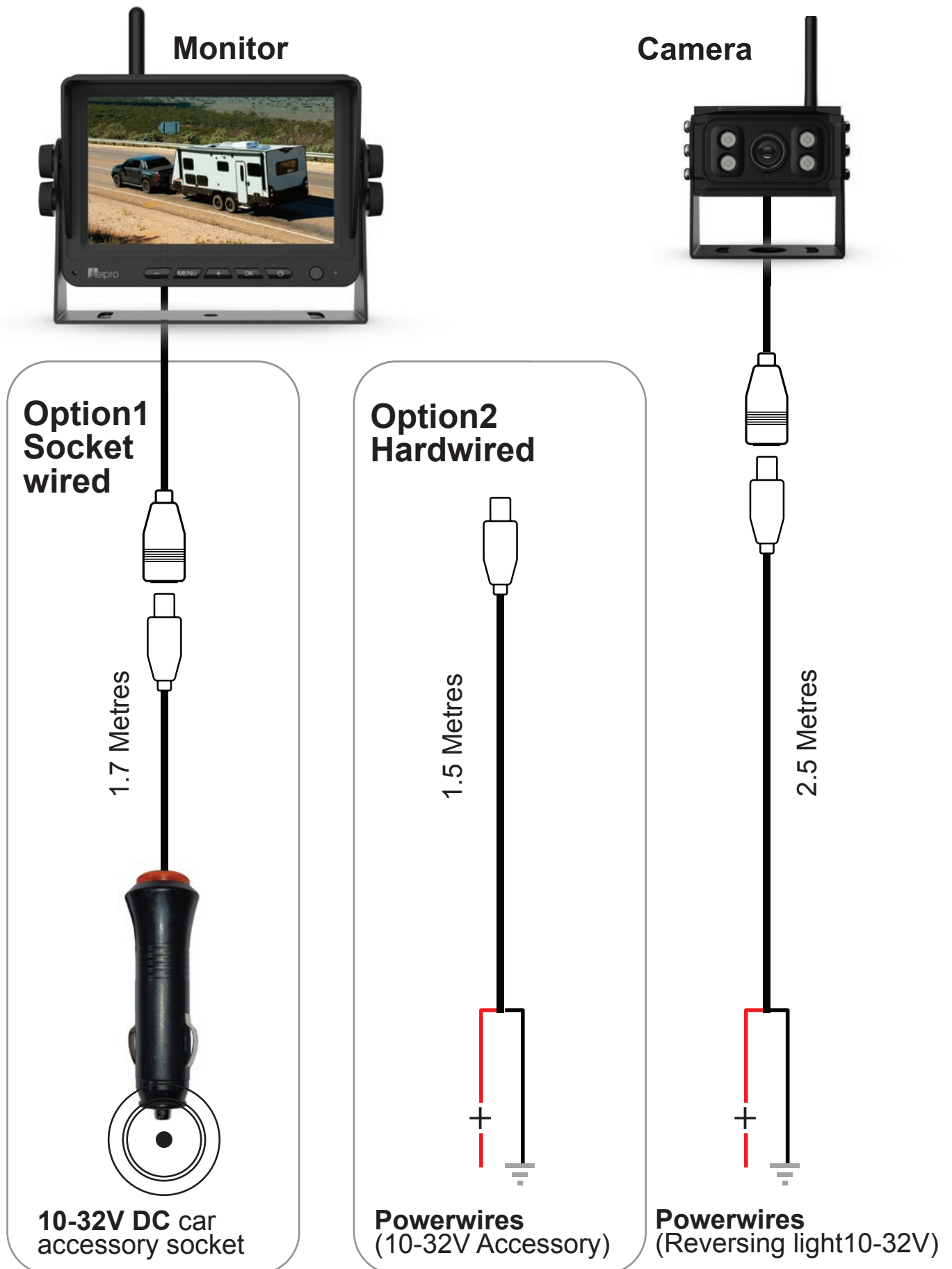

ADVANCED SAFETY **VISION SYSTEMS**

Product information



1. **Monitor wireless antenna**
2. **Screen**
3. **Adjustable monitor angle mount**
4. **Camera wireless antenna**
5. **Guideline:** On home screen quick press OK button
5. **- Selection button**
6. **Menu button:** Press to enter/exit the menu settings
7. **+ Selection button**
8. **OK button:** On home screen can be pressed to turn guidelines ON/OFF
9. **Power button:** Press for 1 second to turn on or off.
10. **Power light (Blue)**
11. **Adjustable camera angle mount**
12. **IR lights**
13. **IR Sensor**
14. **Camera lens**

ADVANCED SAFETY VISION SYSTEMS

Menu operation

When the monitor is on, press the “MENU” button to enter into the menu settings.
Press the “+ / -” buttons to increase or decrease the parameter setting.
Press the “OK” button to confirm setting.

Main menu

Language/Picture Flip / Backlight Brightness / Factory Default / System Information / Camera Pair

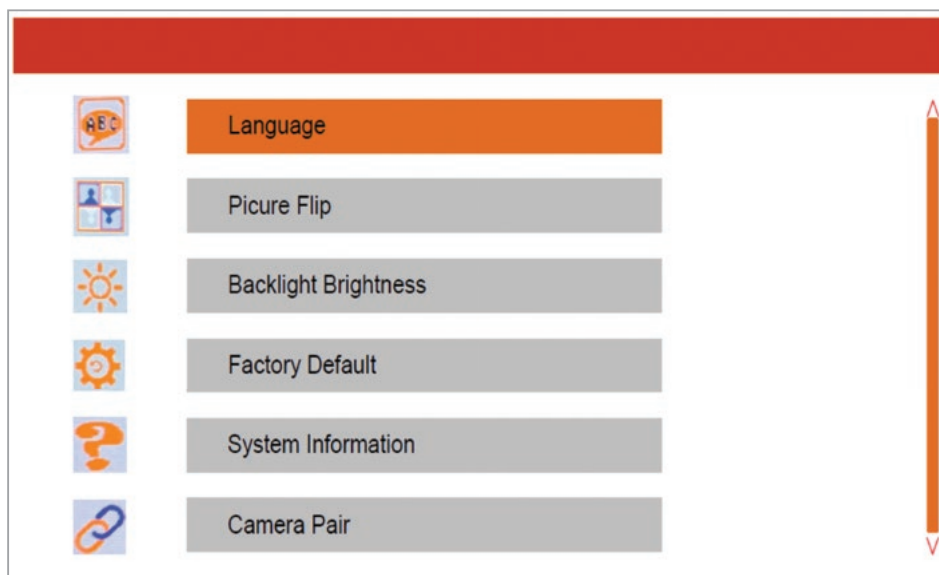

Language

Press the “OK” button to enter the language choice interface and press the “+ / -” buttons to select required language.

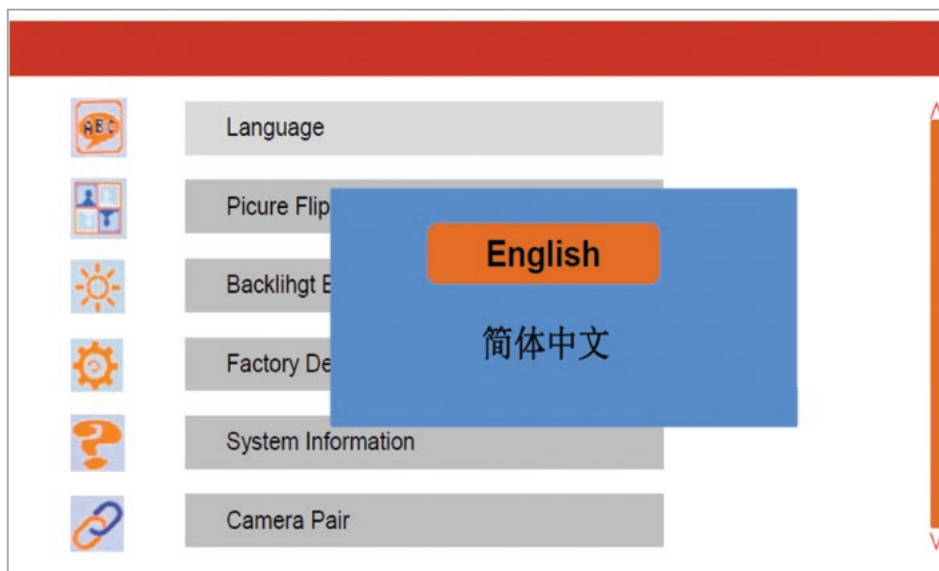

ADVANCED SAFETY VISION SYSTEMS

Menu operation

Picture Flip

Press the “OK” button to enter the picture flip interface and press the “+ / -“ buttons to turn mirror and flip function on/off

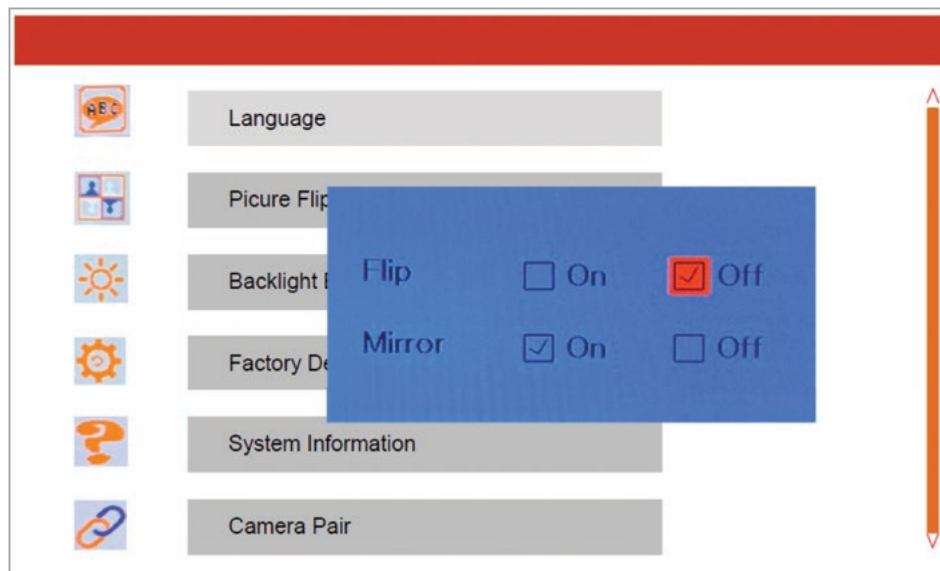

Backlight Brightness

Press the “OK” button to enter the backlight brightness interface and press the “+ / -“ buttons to adjust.

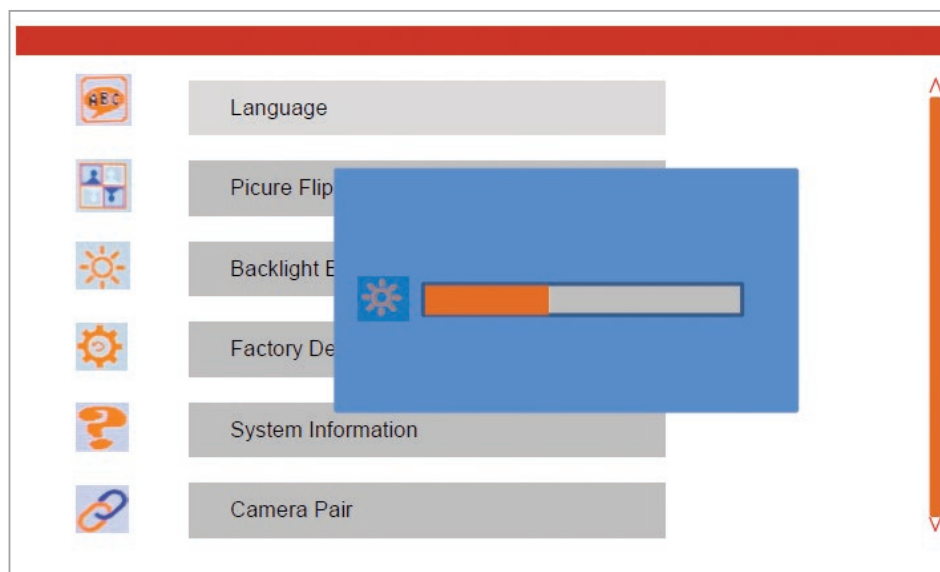

ADVANCED SAFETY VISION SYSTEMS

Menu operation

Factory Default

Press the “OK” button to enter the factory default settings and press the “+ / -“ buttons to select yes or no to restore the monitor to default factory settings.

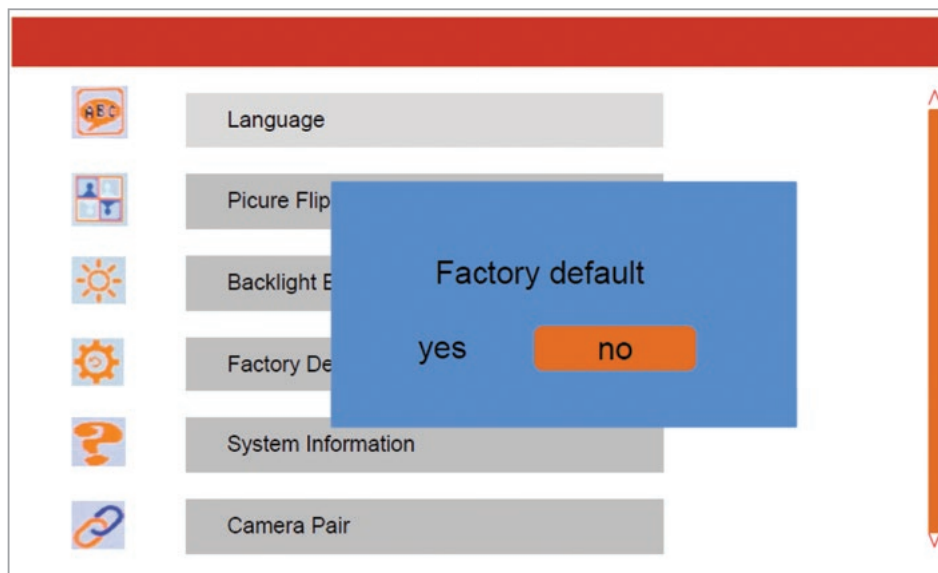

System Information

Press the “OK” button to enter the system information setting to show pairing camera and firmware information,

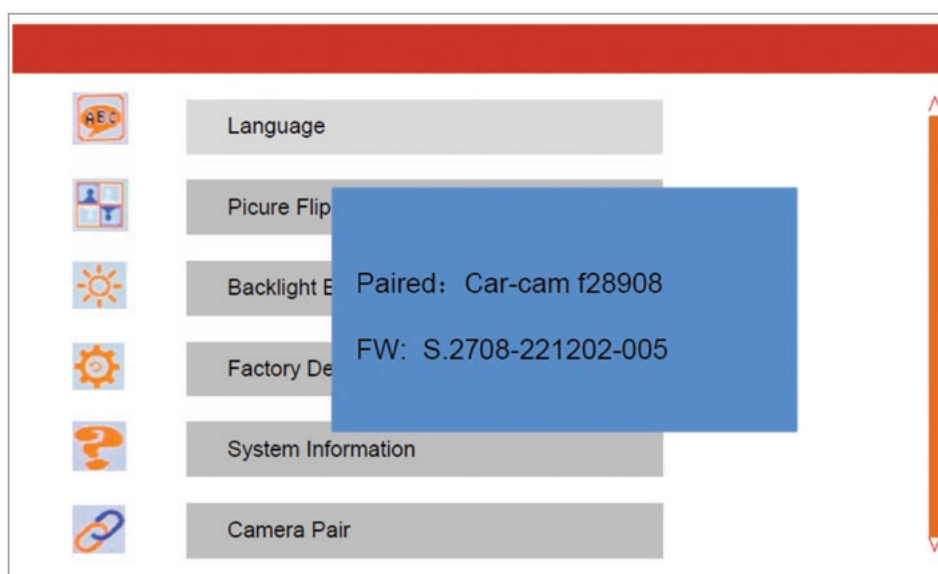

ADVANCED SAFETY **VISION SYSTEMS**

Menu operation

Camera Pair

Press the “OK” button enter to the camera pair settings. With the camera powered a text window will appear on screen saying “searching” .

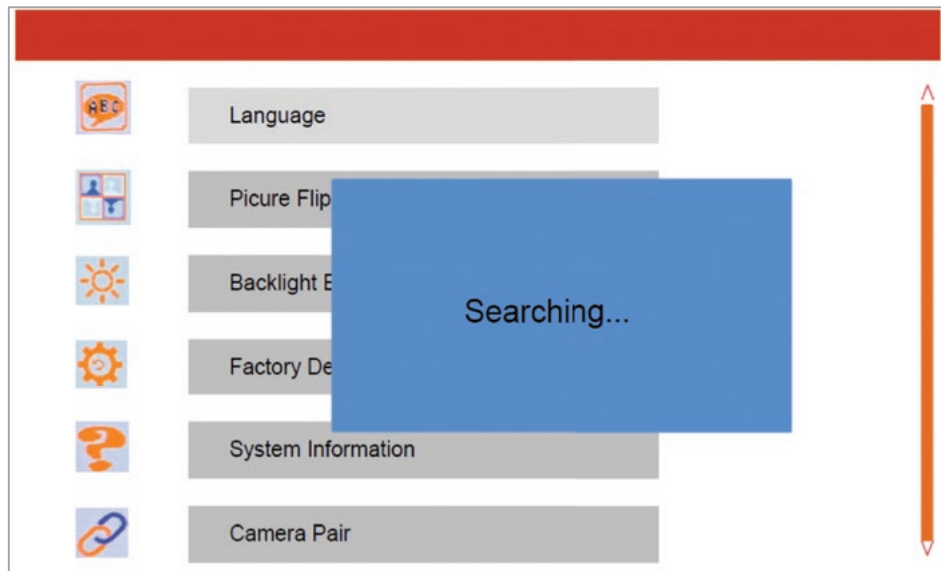

After a few seconds the camera name for pairing will appear. Press the “OK” button to confirm camera.

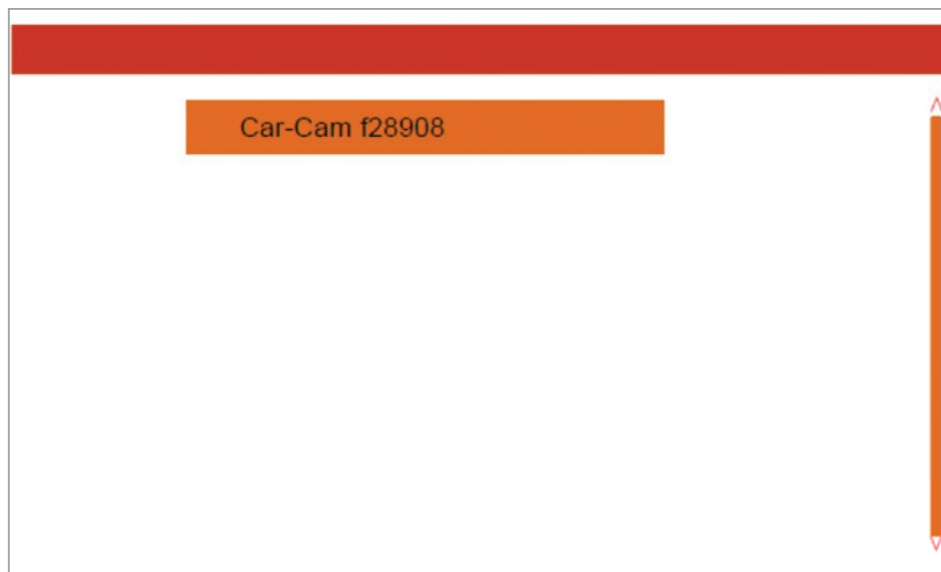

ADVANCED SAFETY VISION SYSTEMS

Menu operation

Once successfully paired, a text window will appear saying “Pairing successful”, and the camera will activate.

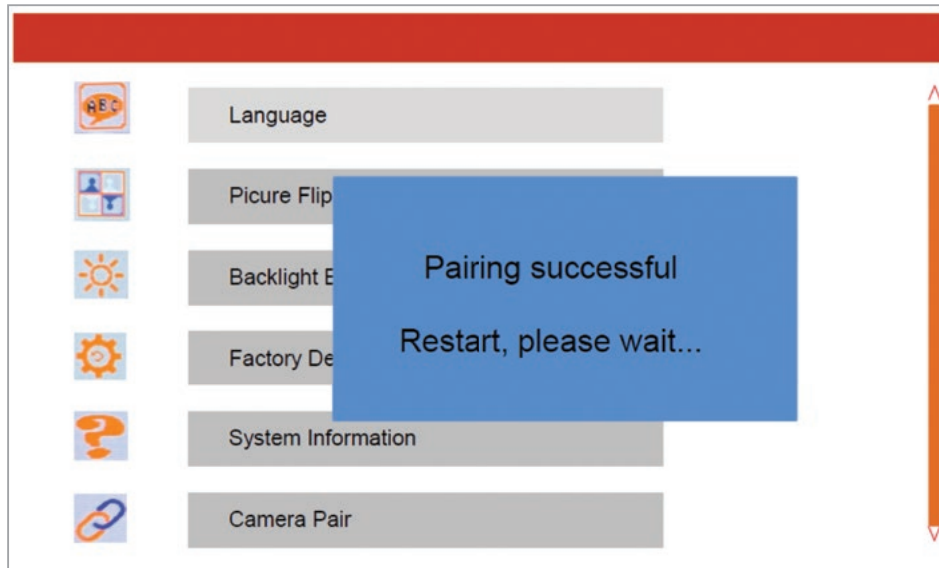

ADVANCED SAFETY VISION SYSTEMS

Specifications

- Display: 5" IPS Display
- Resolution:
 - Monitor: 800 x 480
 - Camera: 1280 x 720
- Wireless HD 720P reverse camera
- Lens Angle: 110 Degrees
- Wireless Frequency: 2.4Ghz
- Wireless Range: 150 metres
- 4x IR LEDs
- Luminance: 350 cd
- Monitor View: Normal / Reverse
- Guidelines: Selectable On/Off (monitor)
- Audio: On board Speaker
- Power Supply: 10-32V (Hardwired)
- Dimensions (WxHxD):
 - Monitor Only: 133 x 95 x 22mm
 - Monitor and Bracket: 152 x 146 x 53mm
 - Camera: 76 x 48 x 64mm
 - Camera and Bracket: 76 x 128 x 84mm
- Inclusions:
 - 5" Wireless monitor
 - 1 x Wireless HD 720P reverse camera
 - Monitor mount
 - Sunvisor
 - 1.5m Monitor cable
 - 1.7m Power adapter (DC Jack)
 - 2.5m Camera cable

ADVANCED SAFETY VISION SYSTEMS

Technical assistance

If you need assistance setting up or using your Aerpro product now or in the future, call Aerpro Support. Australia

TEL: 03 – 8587 8898

FAX: 03 – 8587 8866 Mon-Fri 9am – 5pm AEST or EMAIL: service@tdj.com.au

If you would like to download a digital copy of this manual, or other Aerpro manuals/software, please visit the Aerpro.com website and search for the product model number for more information, accessories and products.

This manual is considered correct at time of printing but is subject to change.

For latest manuals and updates refer to the website.

Copyright © 2024 by TDJ Australia

All rights reserved. No part of this publication may be reproduced, distributed, or transmitted in any form or by any means, including photocopying, recording, copying or other electronic or mechanical methods, without the prior written permission of the author.

Note: Additional cameras and wiring may be required depending on your application, compatible products are available on our website. For more information Scan the QR code below.

AERPRO.COM



Product
information
and user
manual.