



# 10" ADVANCED INFOTAINMENT SYSTEM

## INTEGRATED HEAD UNIT UPGRADE

to suit **TOYOTA LANDCRUISER 200 SERIES VX/SAHARA 2016-2021**



# AMUTO53

## INSTALLATION MANUAL

# CONTENTS

Tools required.....	2
Product overview.....	2
Inclusions.....	2
Pre-installation checks.....	2
Connection wiring diagram.....	3
Wiring diagram.....	4
Dash disassembly.....	5
Head unit assembly.....	17
Wiring.....	19
Dash reassembly.....	29
Testing the new unit.....	35
Technical assistance.....	36
Brand information.....	36

## Tools required

Use the following tools to make dismantling the dash and the installation of the new kit easier.  
**NOTE:** Do not use power tools, only use the tools recommended below, and do not over tighten screws as they may damage other components. Also take care in removing trim panels as over time they may have become brittle.

**1. Plastic panel remover (pry tool)**



**2. Phillips Head Screwdriver**

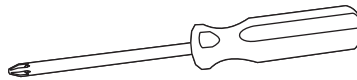

**3. 10mm socket, extension, and ratchet**

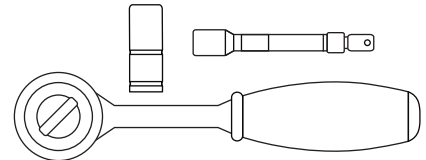

## Product overview

The Aerpro AMUTO53 is a head unit replacement kit to suit the Toyota Landcruiser 200 Series Sahara & VX\* (\*VX only from 2016-2021) models. These kits are Australian designed and engineered to replace the original Toyota head unit and retain the vehicles original functions\* while adding features such as Apple CarPlay, Android Auto, larger 10.1" High Definition display, Dual USB input, and an additional High Definition camera input.

## Inclusions

- Infotainment unit
- Infotainment monitor with physical buttons
- Mounting brackets and screws
- Power harness
- LVDS cable
- MOST / GPS / DAB / USB / 360 retention harnesses
- Audio visual lead
- 720p AHD Surface Mount Camera

## Pre-installation checks

**Prior to disassembling the dash and removing the original head unit perform the following checks to determine their functionality:**

- |                                                       |                                                      |
|-------------------------------------------------------|------------------------------------------------------|
| <input type="checkbox"/> Steering wheel controls      | <input type="checkbox"/> Factory vehicle settings    |
| <input type="checkbox"/> 360 degree camera            | <input type="checkbox"/> Bluetooth microphone        |
| <input type="checkbox"/> Parking sensors front / rear | <input type="checkbox"/> Audio output and adjustment |
| <input type="checkbox"/> Climate controls             | <input type="checkbox"/> AM / FM / DAB               |
| <input type="checkbox"/> Hazard light switch          | <input type="checkbox"/> USB port                    |

## Connection wiring diagram

- 1 LVDS Monitor
- 2 Segment Display & Buttons
- 3 MOST Connector
- 4 Factory 360 Camera
- 5 MOST Stereo Connector
- 6 Multiplex Connector
- 7 AM/FM Antenna Plug
- 8 GPS Antenna Plug
- 9 USB 1: CP/AA
- 10 USB 2: Media
- 11 AV Harness
- 12 DAB Antenna Plug
- 13 Multiplex Harness
- 14 Hazard Connector
- 15 360 Camera RCA
- 16 AM/FM Antenna Adaptor
- 17 Microphone
- 18 360 Camera Adaptor (*To be connected to No.4 pictured below depending on vehicle. See P. 25*)

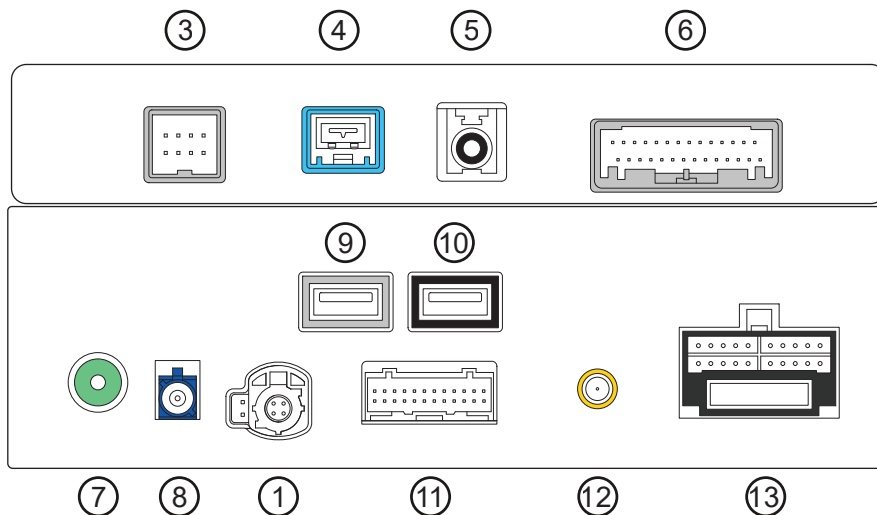
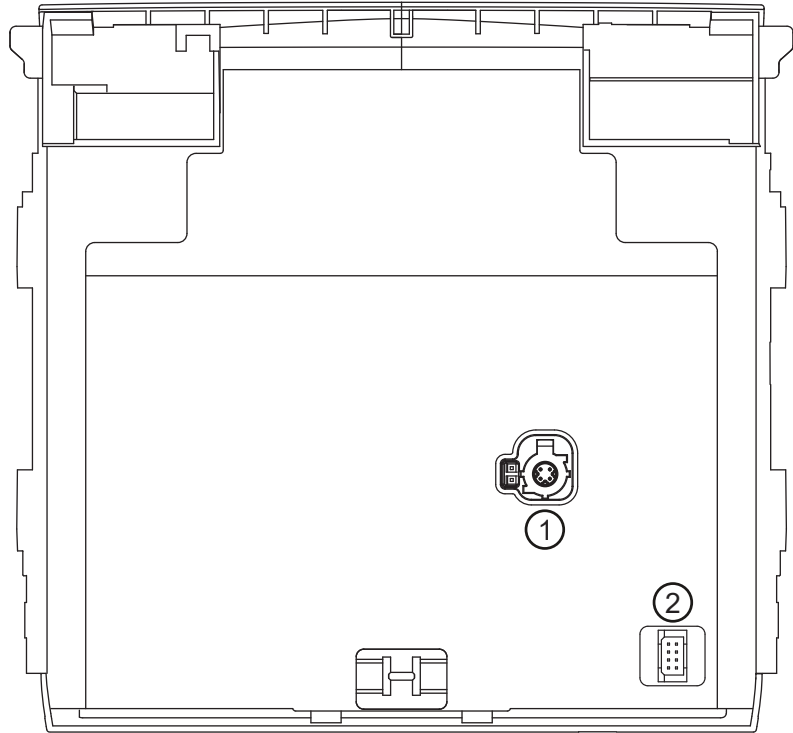

**NOTE: Numbered Plugs are mandatory for head unit to function correctly**

# Wiring diagram

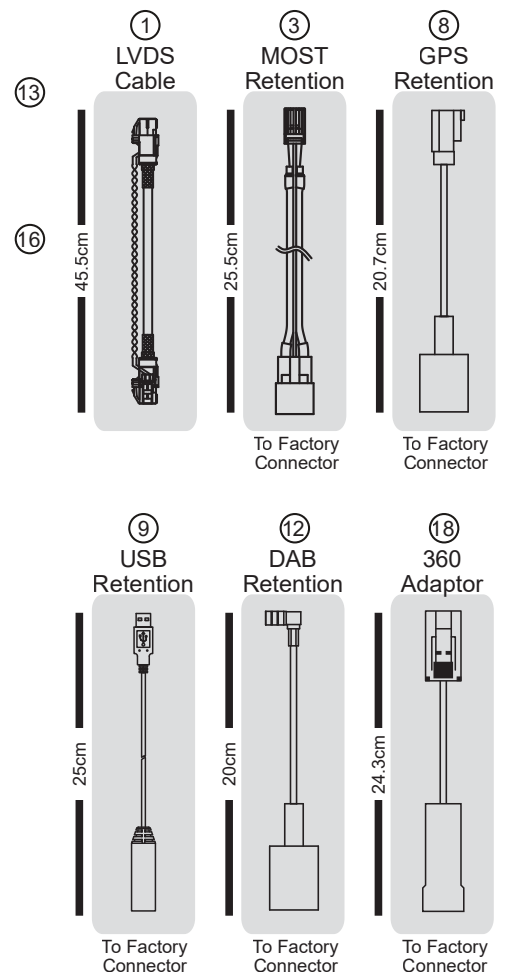
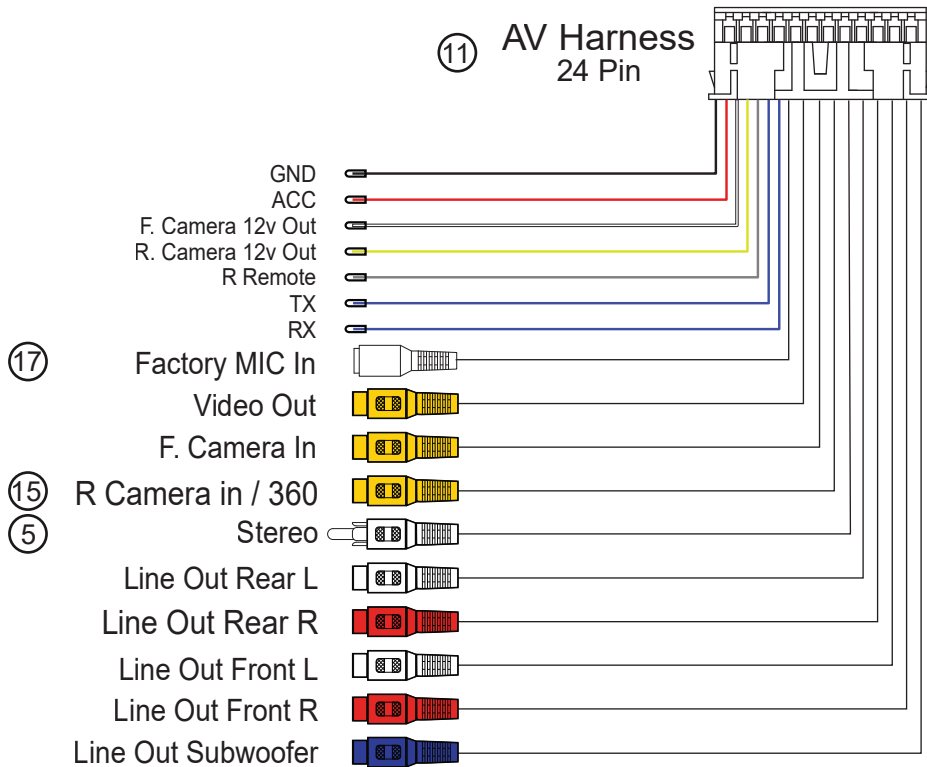
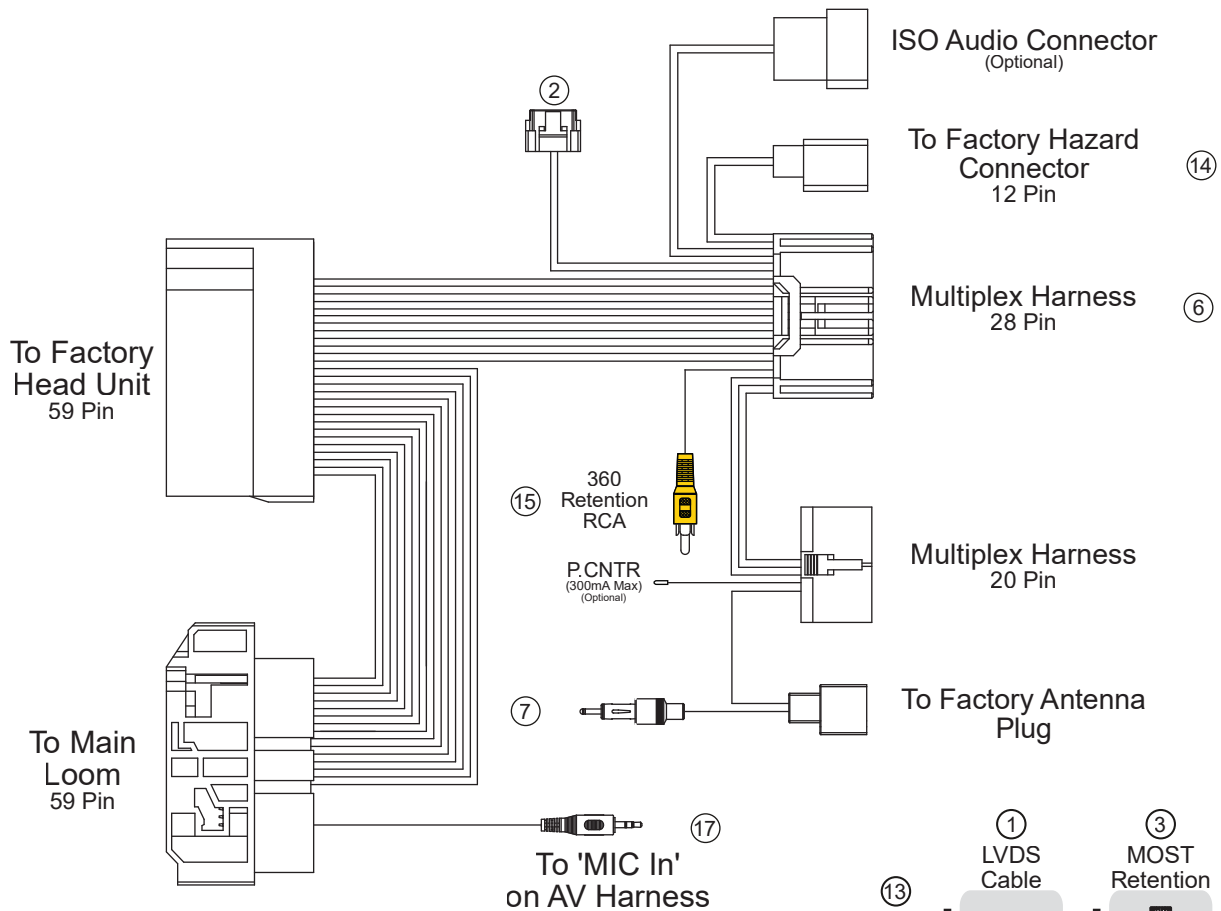

## Dash disassembly

Remove the panel which is located by the left knee of the driver by pulling it firmly toward yourself. Place this panel aside.



Remove the 10mm bolt indicated in figure 1.





## Dash disassembly cont.....

Remove the panel with the engine start / stop button by pulling it firmly on an angle toward yourself as indicated in figure 2.



Disconnect the harness leading to the engine start / stop button. Place this panel aside.



## Dash disassembly cont.....

Repeat the process on the opposite side, remove the panel located by the right knee of the passenger by pulling it firmly toward yourself. Place this panel aside.



Remove the 10mm bolt as per previous side.





## Dash disassembly cont.....

Remove the panel indicated in figure 3 as per the previous side. Place this panel aside.



Using either the physical key of the vehicle or a flat head screw driver, remove the cover over the transmission levers shift lock.



## Dash disassembly cont.....

Once the shift lock cover has been removed, using either the physical key or a flat head screw driver, press the shift lock button down to allow you to move the transmission lever down to the Drive position, out of the way.



Remove the storage compartment panel below the stereo controls by pulling firmly toward the rear of the vehicle (You may require the connected harnesses to be disconnected to have this panel completely removed). Place this panel aside.





## Dash disassembly cont.....

Remove the air vents from both sides by gently using a plastic pry tool around the edges to detach them from the dash. Place them both aside.



## Dash disassembly cont.....

Remove the grille at the top of the dash by gently using a plastic pry tool along the front edge and both sides to release the clips. Once lifted out of its place, disconnect the light sensor harness attached to it. Place this panel aside.



## Dash disassembly cont.....

Remove the 2x 10mm bolts from under the grille at the top of the dash indicated in figure 4 and place them aside.



Remove the 2x 10mm bolts from behind the air vents either side of the stereo indicated in figure 5/6 and place them aside.





## Dash disassembly cont.....

Remove the original screen by pulling it firmly toward the rear of the vehicle. Once the clips have been released it can be flipped up to allow the 4x harnesses to be disconnected. This panel will no longer be required.

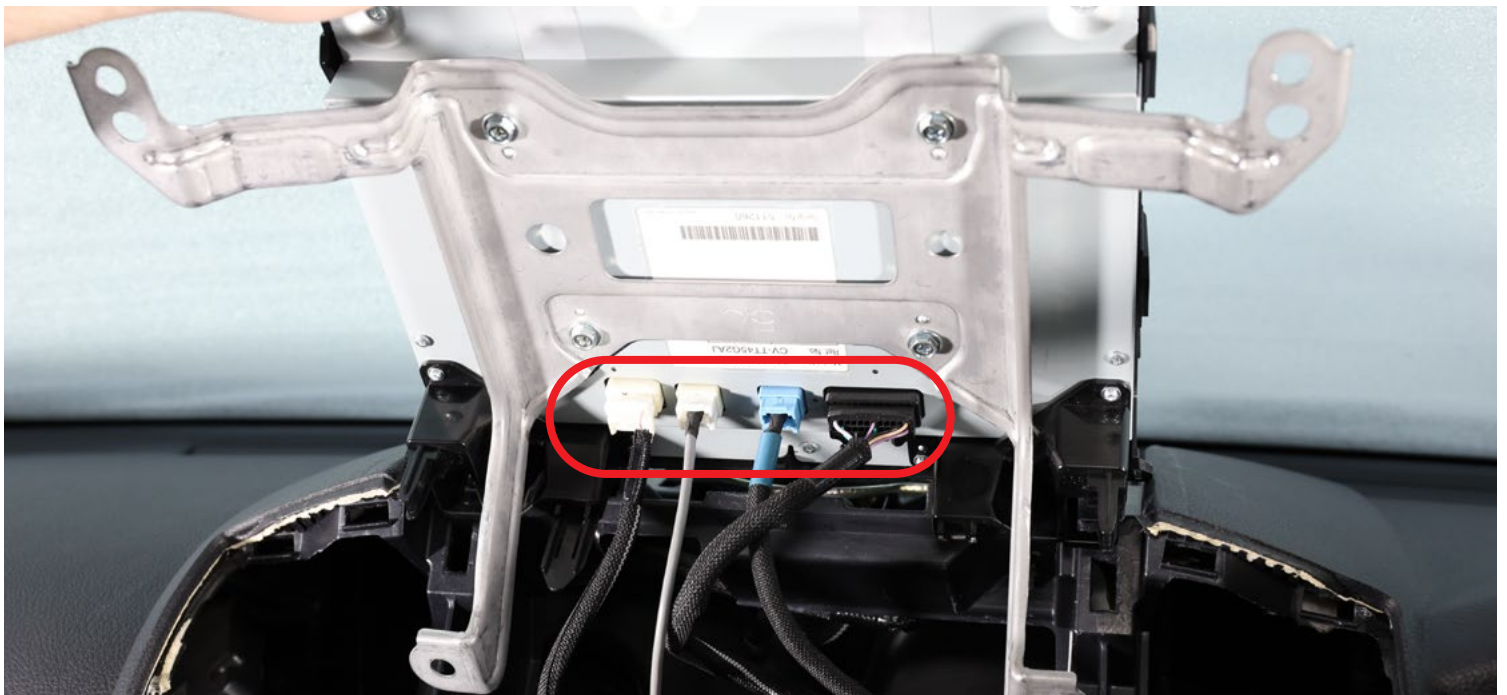

## Dash disassembly cont.....

Remove the 2x 10mm bolts from behind the original screen indicated in figure 7 and place them aside.



Remove the 2x 10mm bolts from beside the 2x original dials indicated in figure 8 and place them aside.





## Dash disassembly cont.....

Remove the original climate controls and stereo dials by pulling them firmly toward the rear of the vehicle. Once the clips have been released you can access and disconnect the 9x harnesses. Place this unit aside.



Dash disassembly cont.....

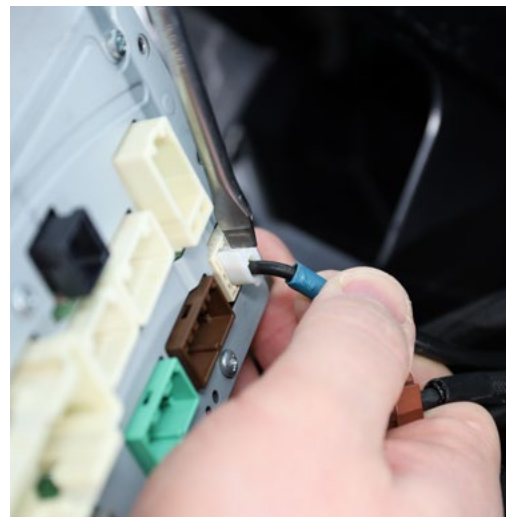
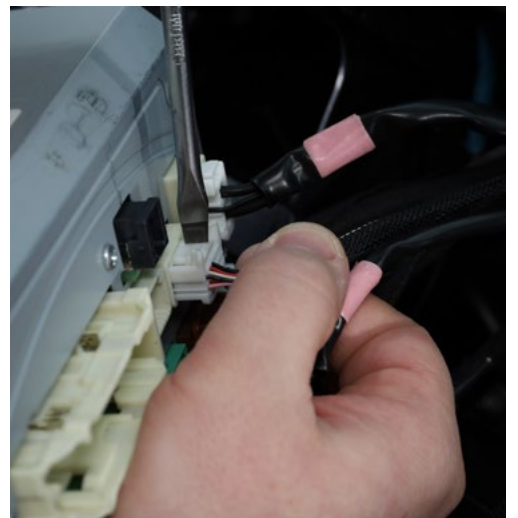
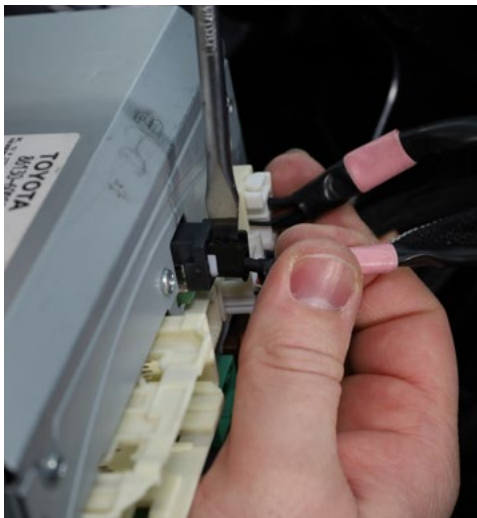
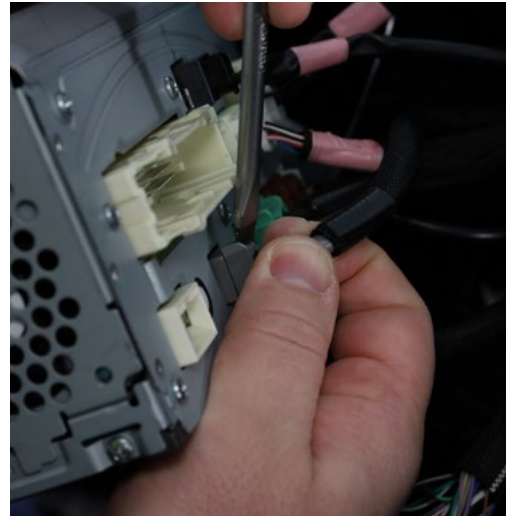
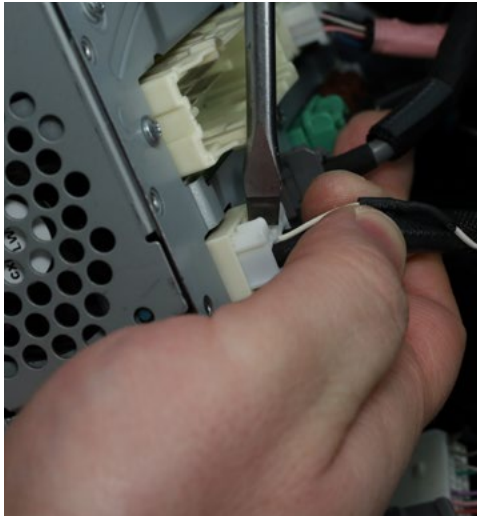



## Head unit assembly

On a workbench attach the mounting brackets to the new head unit using the 8 x supplied Phillips head screws. The brackets and new head unit chassis are marked "L" and "R" to designate which sides they are to be mounted to.





Head unit assembly cont.....



## Wiring

Connect the wiring harnesses supplied with the new kit to the new head unit as indicated in the wiring diagram on pages 3-4 and then to the vehicles original harnesses

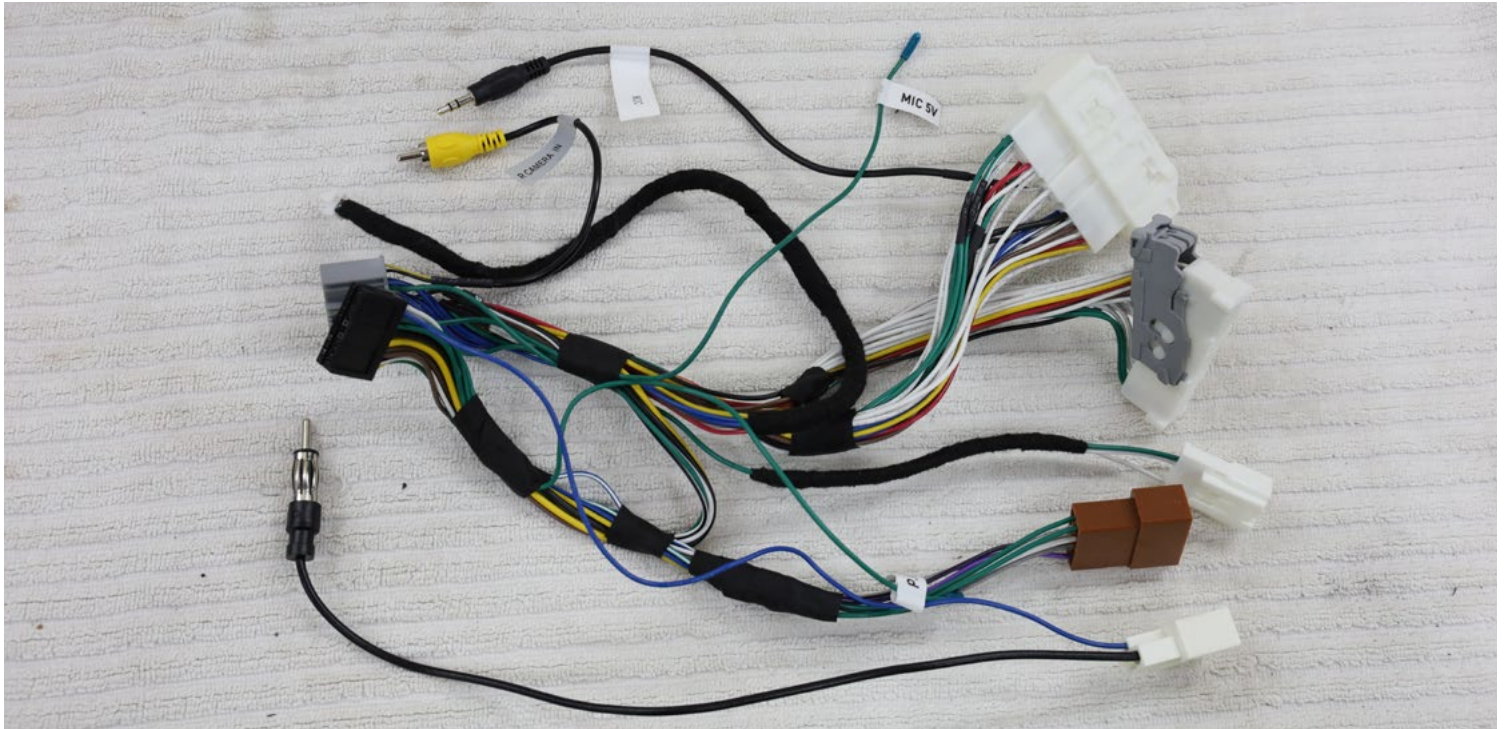

**NOTE:** The following connections need to be made to the head unit while on the workbench. Main power harness (black 20-pin plug) (13)

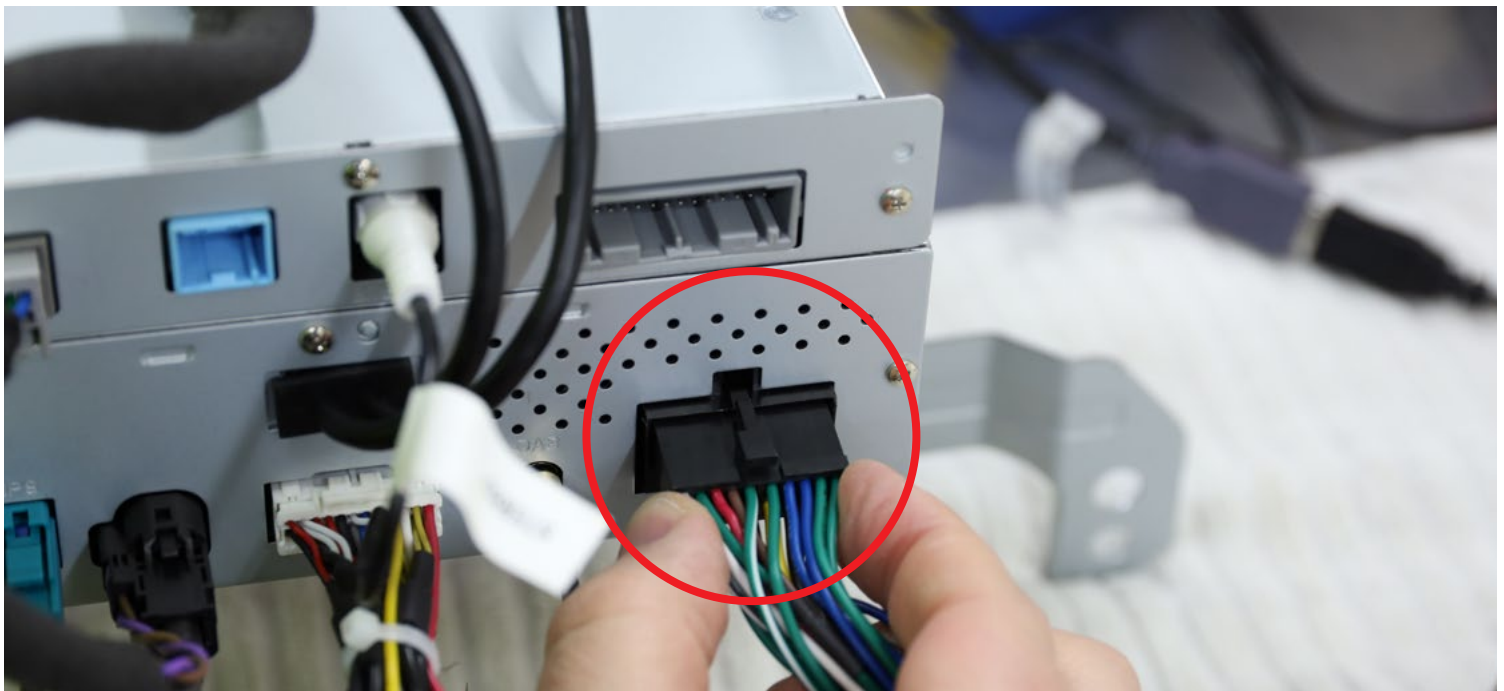



## Wiring cont.....

Multiplex harness (grey 28-pin plug) (6)

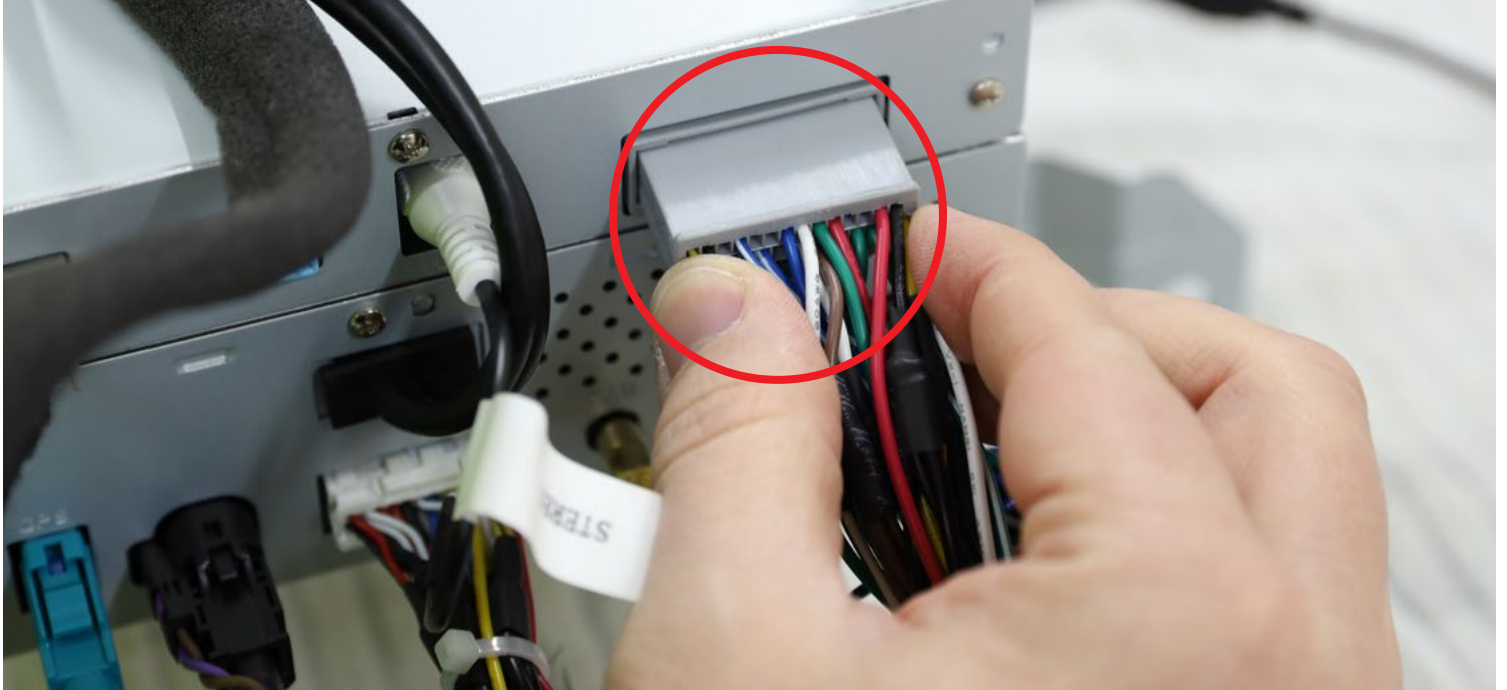

AV harness (white 24-pin plug) (11)



## Wiring cont.....

AM/FM antenna adaptor plug (7)



GPS antenna adaptor plug (8)

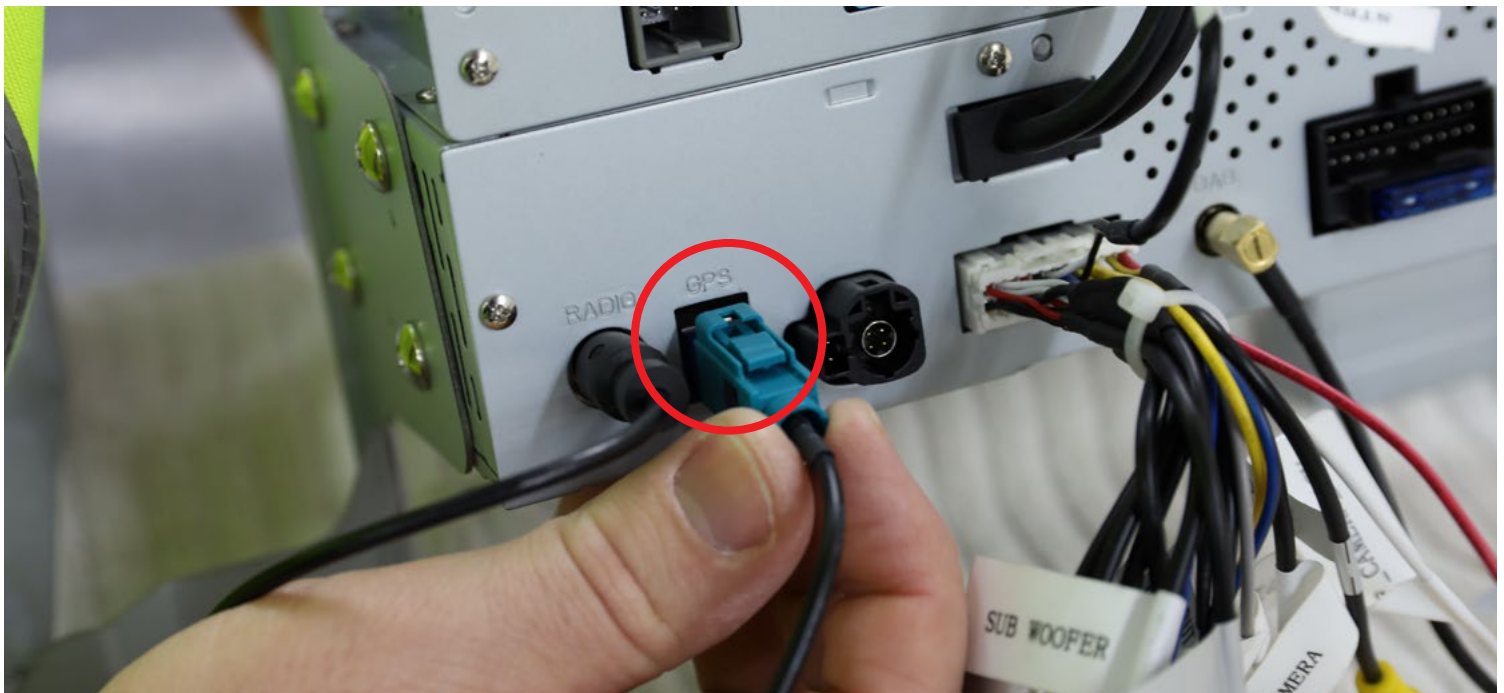



## Wiring cont.....

LVDS lead plug (1)



DAB antenna adaptor plug (12)





## Wiring cont.....

Stereo RCA (white RCA plug from AV harness labelled "Stereo" connects to RCA socket labelled "Stereo") (5)



MOST harness (grey 8-pin plug) (3)



## Wiring cont.....

### Attention: Vehicles without 360 camera (Reverse Camera Models).

Your factory reverse camera is required to be upgraded using the supplied AHD 720p reverse camera. This kit has not been configured to retain the original reverse camera as it is low resolution. Upgrading the camera is necessary to retain the reverse camera function.

Supplied is an AHD 720p camera designed for replacing the reverse camera of your non-360 camera vehicle. However if you have a vehicle with 360 camera support, this can instead be used as a secondary camera.

You can wire it up using the reverse lights of the vehicle or connect it to the head units AV harness's camera power outputs (R. Camera 12v Out / F. Camera 12v Out)

**NOTE: Putting the vehicle in reverse will send 12v out from the 'R. Camera 12v Out' cable. Pressing the second camera icon on the homescreen will send 12v out from the F. Camera 12v Out cable.**

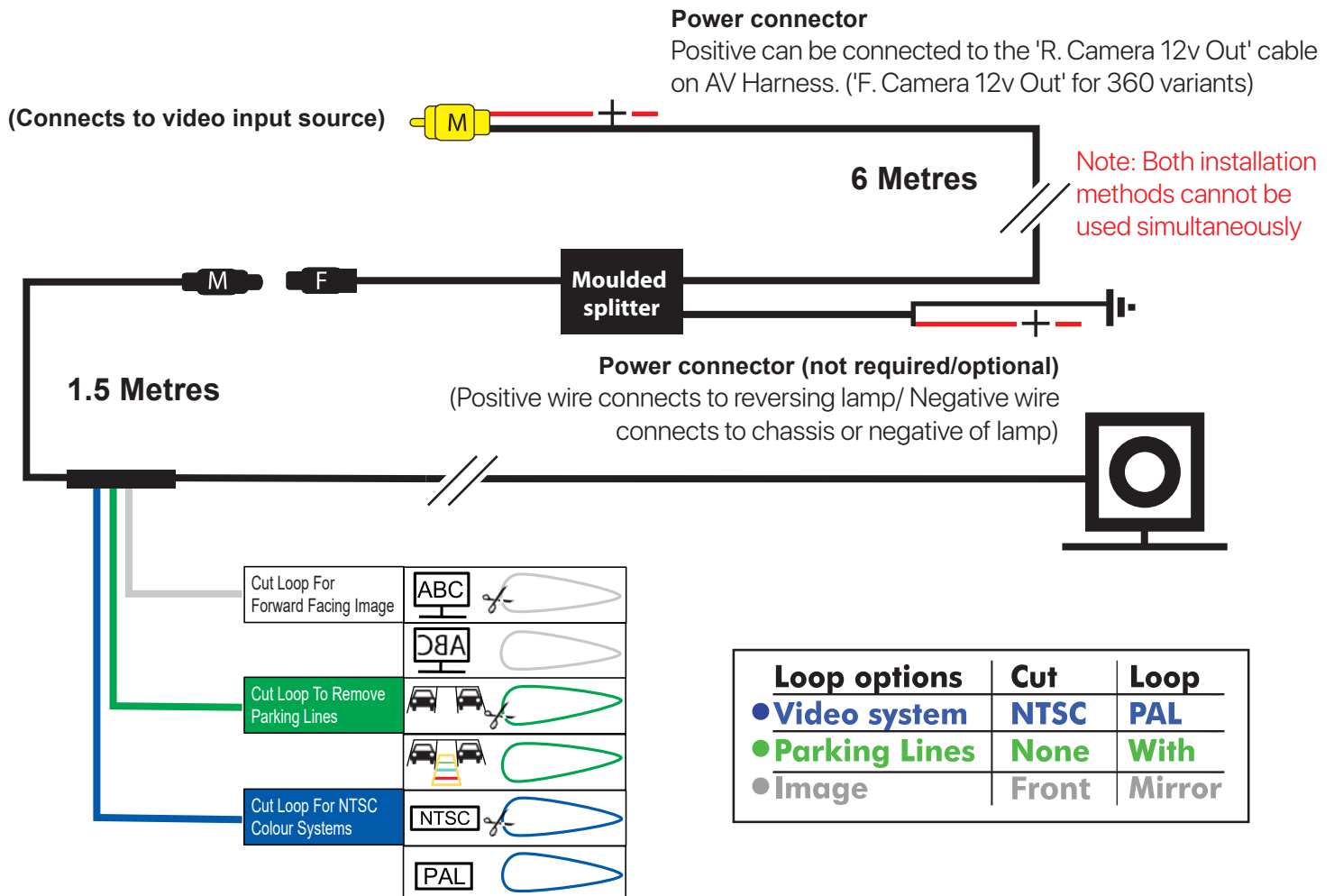

## Wiring cont.....

**NOTE: The following connections need to be made to the head unit in the vehicle.**

The following leads pictured below are required to retain the Hazard switch and 360 degree camera. The white 12-pin Hazard switch plug in the vehicle will connect to the white 12-pin Hazard switch socket of the new harness (14). The square 360 degree camera plug connects to the 360 degree camera socket on the back of the new unit (4).

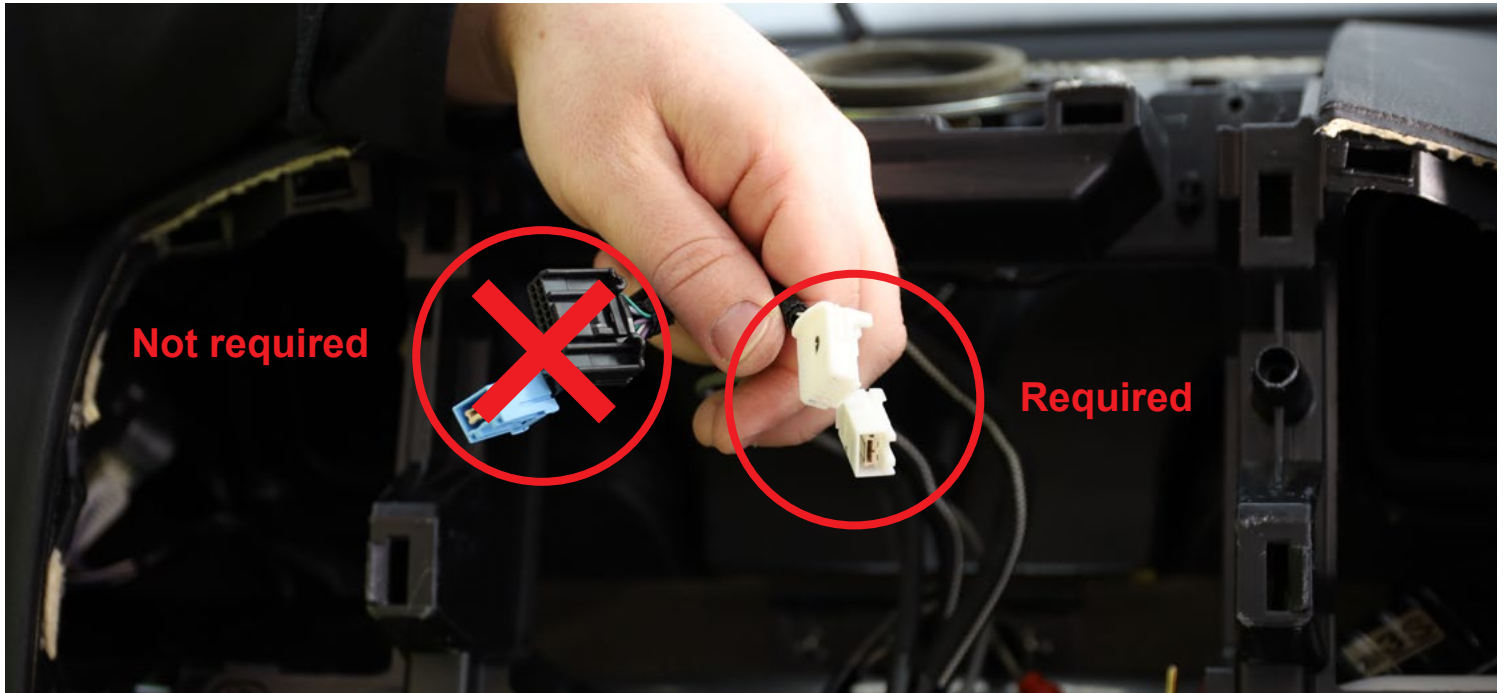

Connect the 360 degree camera harness (4). For the Australian region, **the 360 camera plug is white or black and not blue.** If your vehicle has a 360 camera connector like Figure 9 you can plug the white connector straight into the back of the head unit. If your 360 camera vehicle connector is like Figure 10, then you will need to use the included 360 camera adaptor to convert the 360 plug, and then connect it to the back of the head unit.

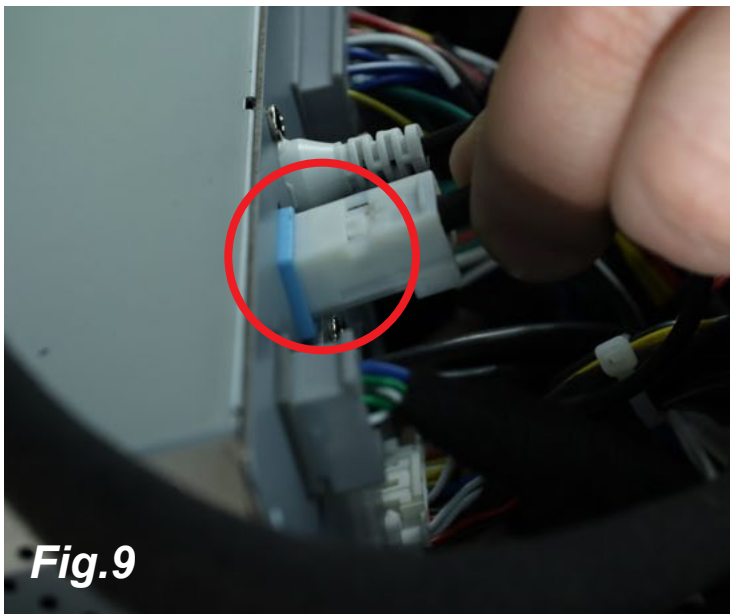

Fig.9

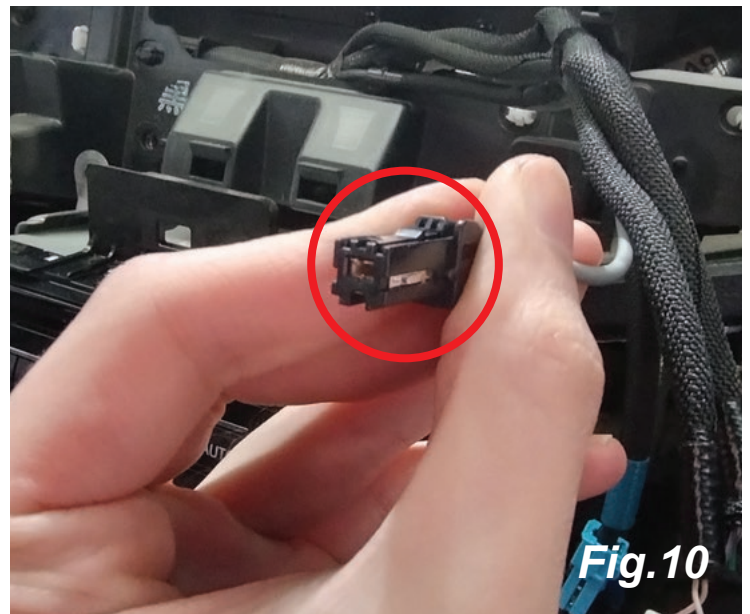

Fig.10



## Wiring cont.....

The following leads are to be routed beside or underneath the new head unit but above the plastic dash support (these will connect to the new display): LVDS lead (1)



Hazard switch and climate display harness (white 8-pin plug) (2)

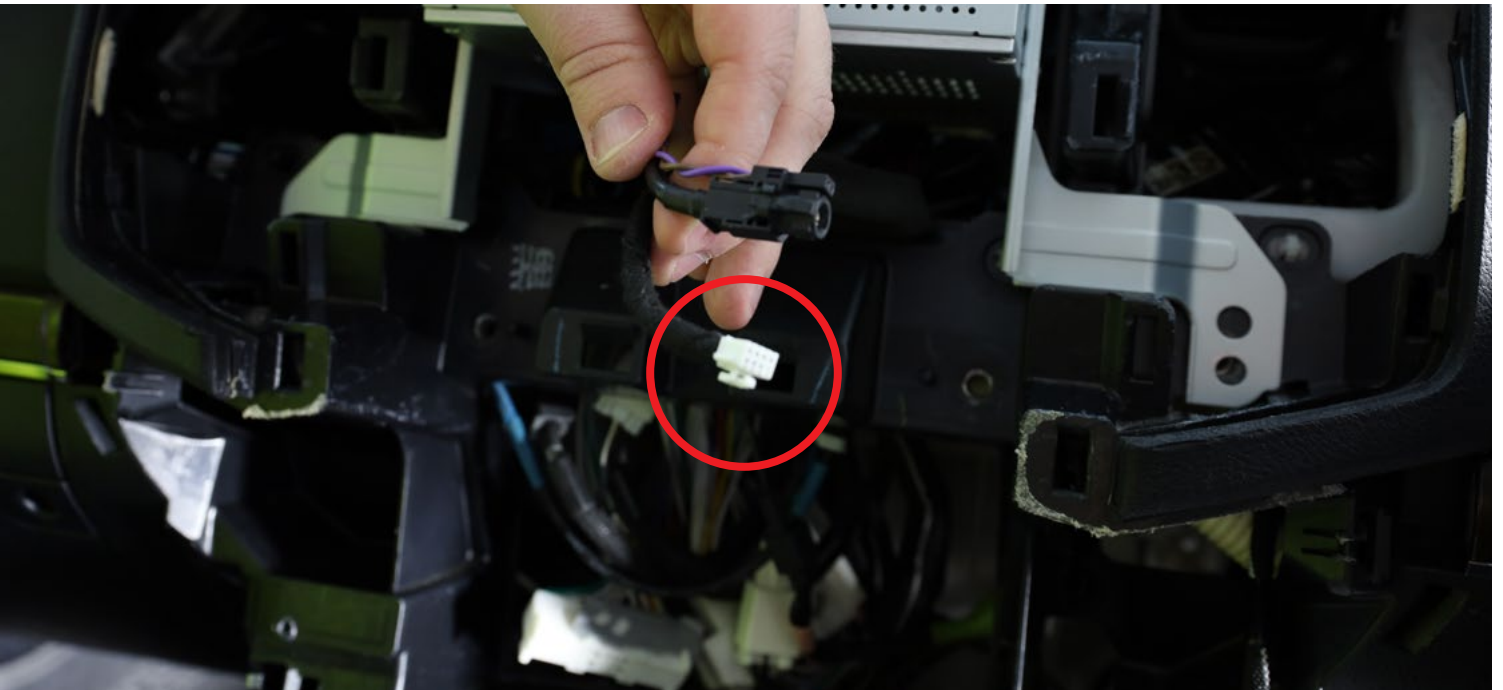

## Wiring cont.....

The following leads are to be routed down behind the plastic dash support and connected to their corresponding original harnesses.

AM/FM antenna adaptor (7)

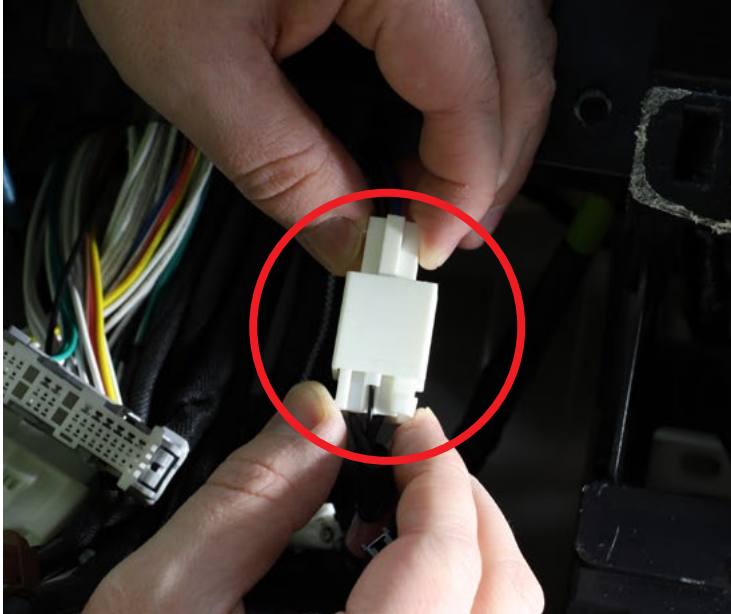

GPS antenna adaptor (8)

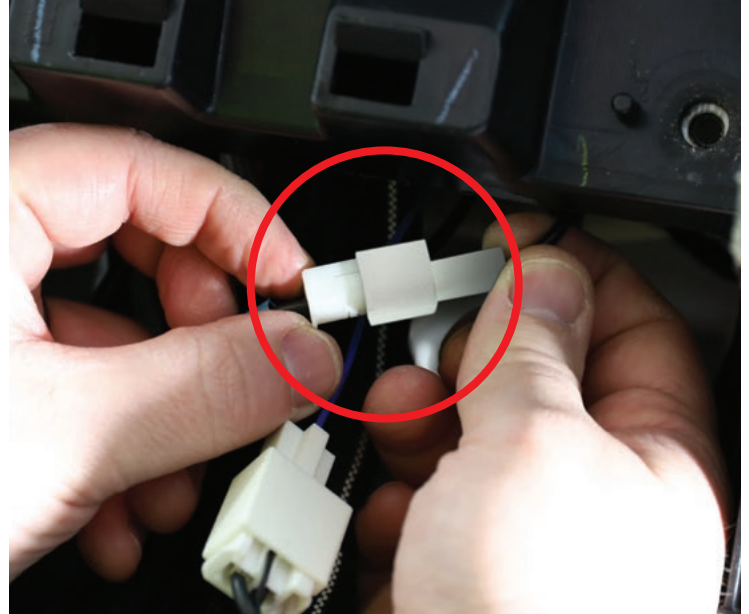

DAB antenna adaptor (12)

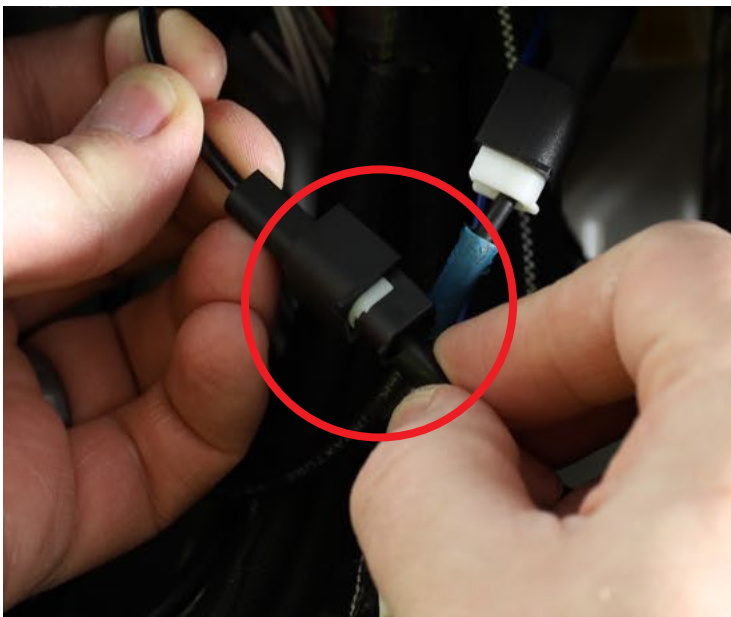



## Wiring cont.....

The following leads are to be routed down behind the plastic dash support and connected to the original climate control system. Locking multiplex harness (white 59-pin plug and socket)  
The new 59-pin plug is to be connected to the socket of the original head unit.

**NOTE: Make sure that the connection is done slowly, ensuring that all the pins make contact and aren't bent or loose on installation.**

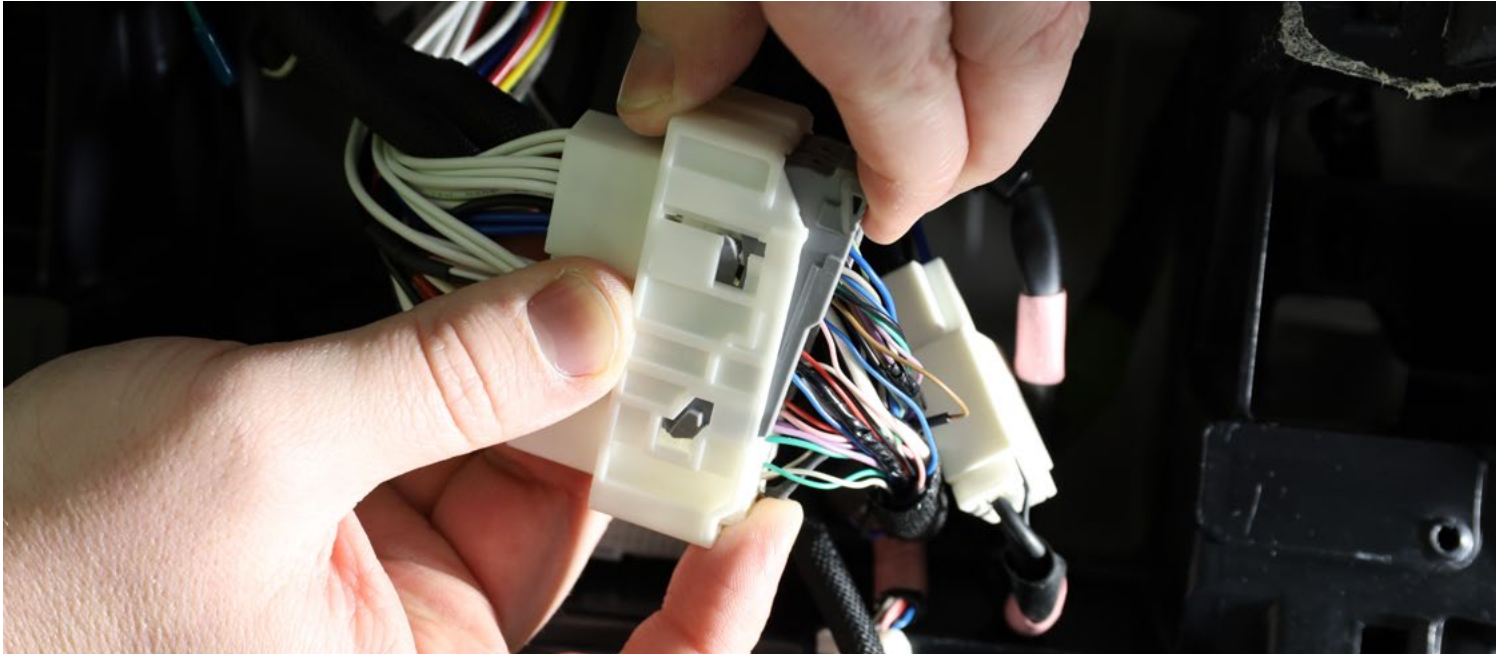

The new 59-pin socket is to receive the original 59-pin plug which was disconnected from the original climate control system.

**Do not connect anything other than the 59-pin plug to the back of the climate control system. Connecting other factory plugs may interfere with the functionality of the new head unit.**



## Dash reassembly

The new head unit can be secured into the dash using 4x of the 10mm bolts which have been placed aside.

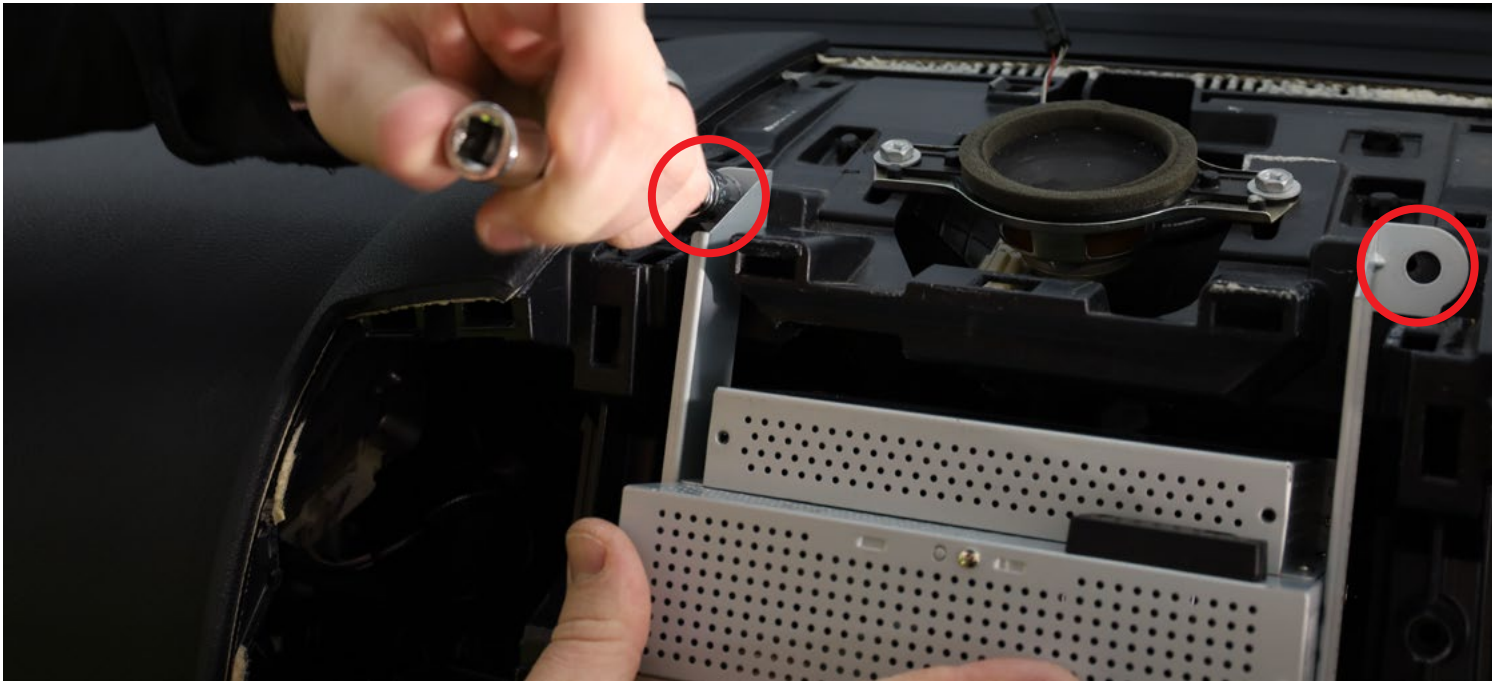



## Dash reassembly cont.....

The original head unit including the original climate controls can be secured into the dash using 4x of the 10mm bolts which have been placed aside.

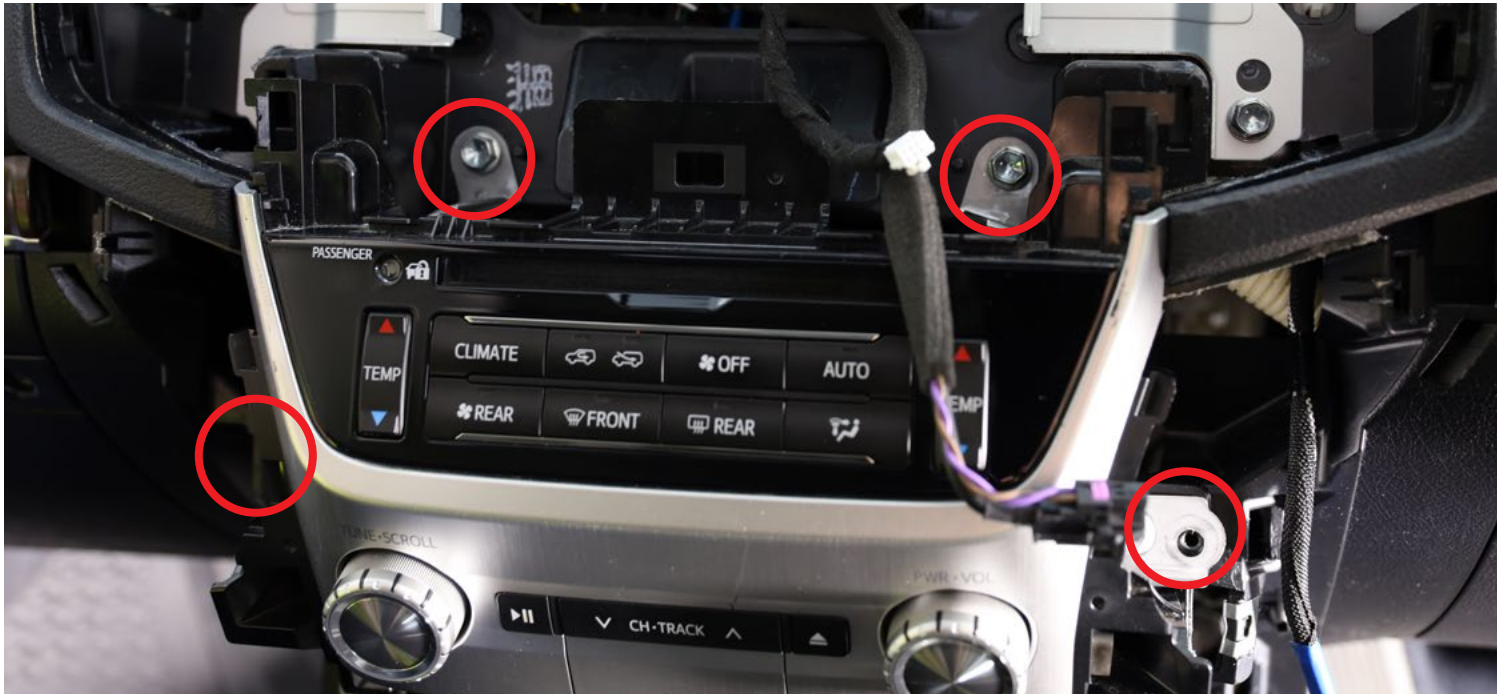

The new display can be connected using the LVDS plug (1) and the hazard switch plug (white 8-pin plug) (2)

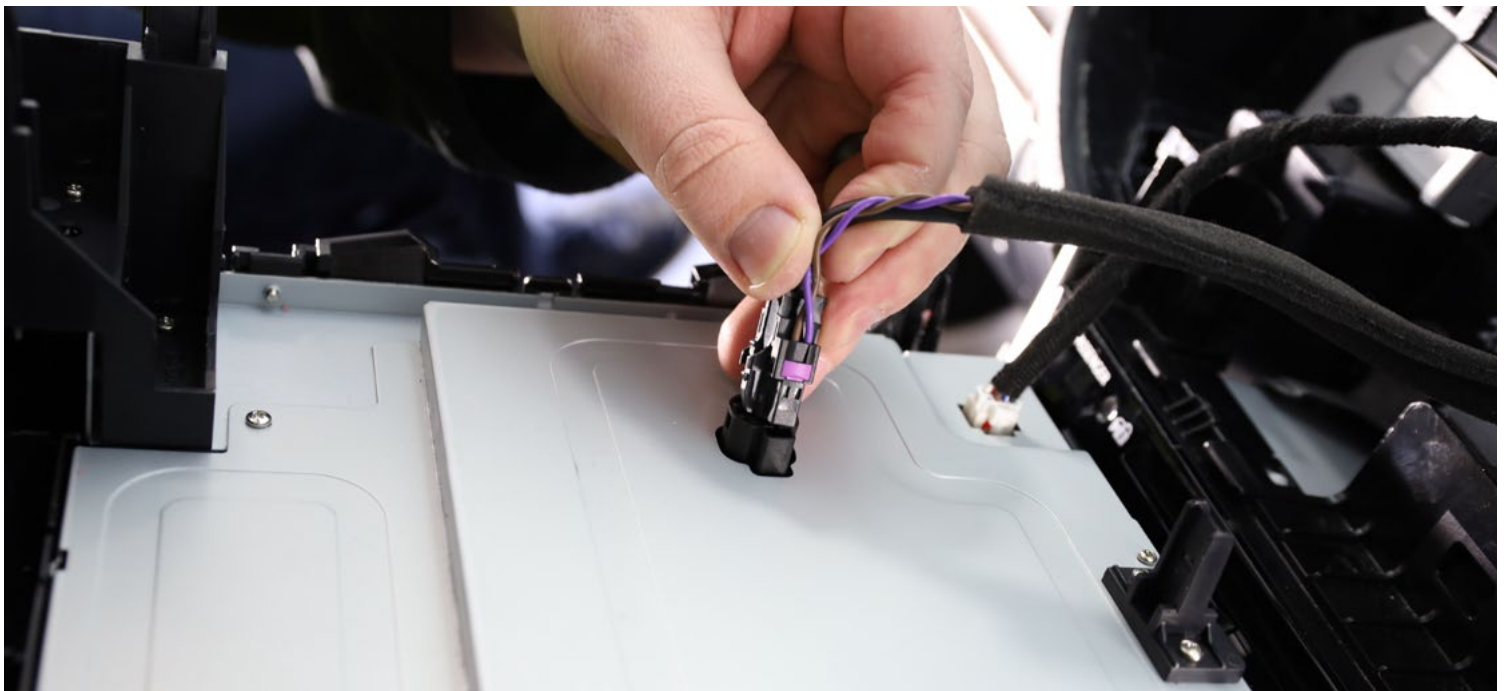



## Dash reassembly cont.....

The new display can be clipped into its place by firmly pushing it in with even pressure by hand.



The dash top panel can be replaced by first connecting the original light sensor harness and then clipping it into place by firmly pushing it down with even pressure by hand.



## Dash reassembly cont.....

The air vents can be replaced by firmly pushing them into place with even pressure by hand



The pocket below the original stereo can be replaced by firmly pushing it into place with even pressure by hand. (You may require the harnesses to be reconnected before replacing this panel).





## Dash reassembly cont.....

The transmission lever can now be returned to the Park position and the shift lock cover replaced



The start / stop button can be reconnected.

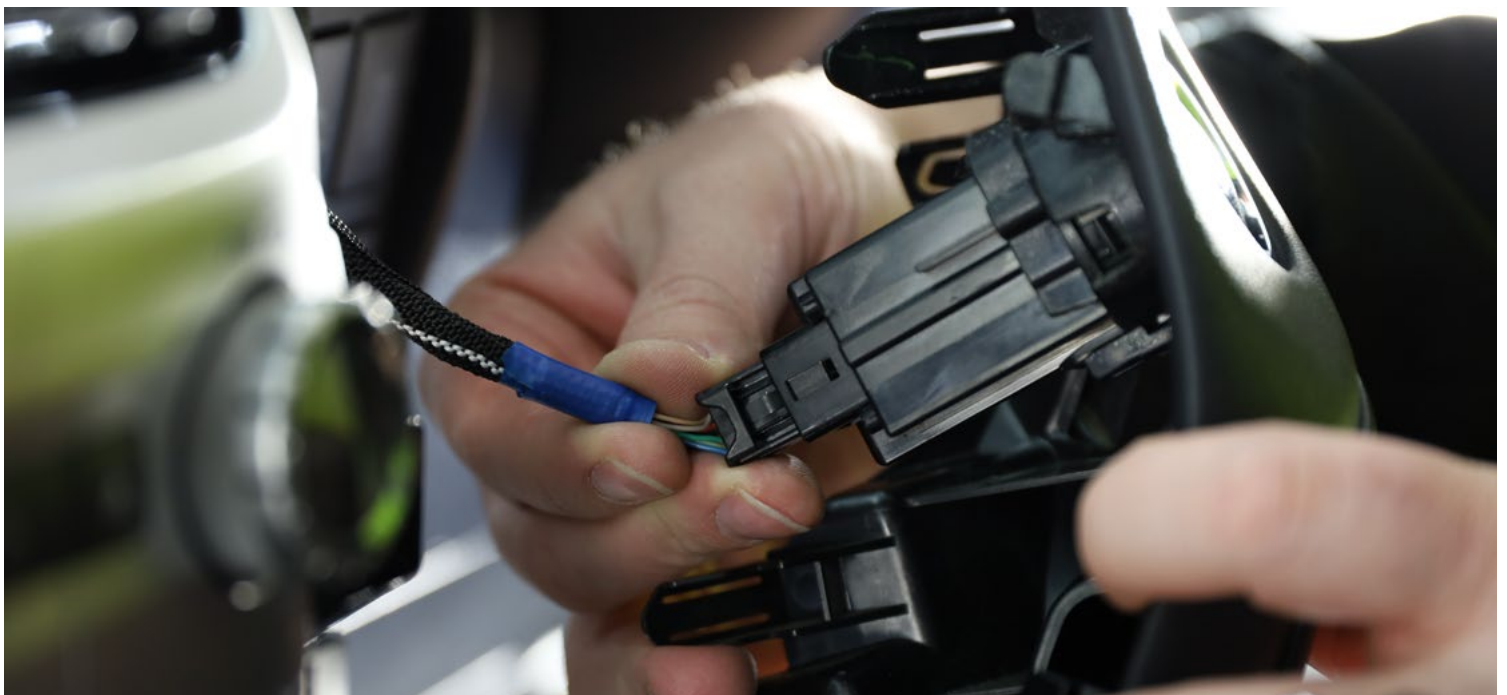



## Dash reassembly cont.....

The panel and its equivalent on the passenger side can be clipped back into place and secured with the 2x remaining 10mm bolts



The panels by the drivers left knee and the passengers right knee can both be clipped back into place

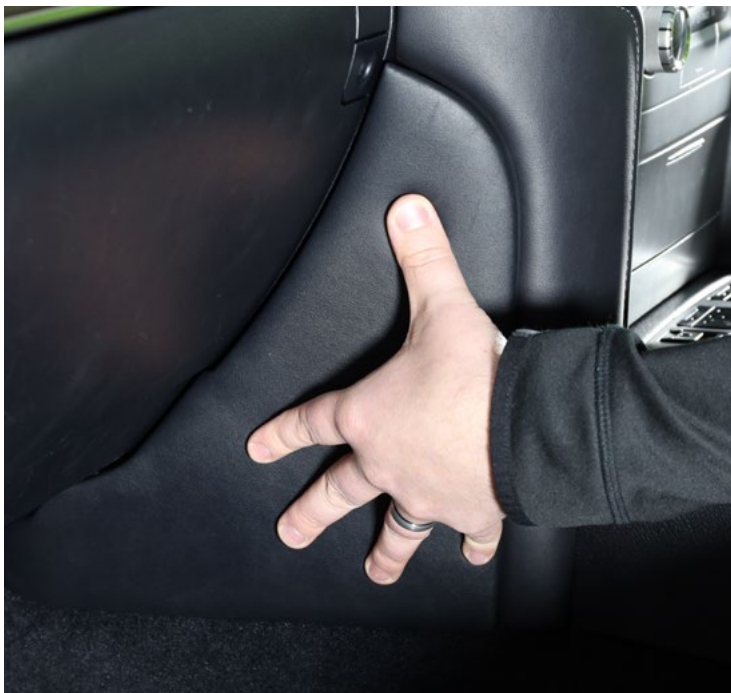

## Testing the new unit

Perform the following checks to determine their functionality:

- AM / FM / DAB
- Apple CarPlay
- Android Auto
- Audio output and adjustment
- Bluetooth microphone
- Steering wheel controls
  - Volume up / down
  - Track change next/ previous
  - Mode
  - Voice control
  - Phone buttons answer / hang up
- USB ports
- 360 degree camera
  - View change button
- Parking sensors front / rear
- Climate controls
  - AC function
  - Temperature up / down
  - Vent location
  - Air re-circulation
  - Fan speed
  - 4-zone setting
  - Demisters front / rear
  - Outside temperature
- Hazard light switch
- Factory vehicle settings
  - Sound settings
  - Rear system\* (\*Sahara only)
  - Door lock settings
  - Climate settings
  - Light settings
  - Toyota park assist settings
- Inclinator (after calibration, refer user manual)
- Second camera (if fitted)

## Technical assistance

If you need assistance setting up or using your Aerpro product now or in the future, call Aerpro Support. Australia

TEL: 03 – 8587 8898

FAX: 03 – 8587 8866 Mon-Fri 9am – 5pm AEST or EMAIL: [service@tdj.com.au](mailto:service@tdj.com.au)

If you would like to download a digital copy of this manual, or other Aerpro manuals/software, please visit the [Aerpro.com](http://Aerpro.com) website and search for the product model number for more information, accessories and products.

This manual is considered correct at time of printing but is subject to change. For latest manuals and updates refer to the website.

Copyright © 2024 by TDJ Australia

All rights reserved. No part of this publication may be reproduced, distributed, or transmitted in any form or by any means, including photocopying, recording, copying or other electronic or mechanical methods, without the prior written permission of the author.

# AERPRO.COM



Scan here for more information on vehicle retention and integration.



Apple CarPlay is a trademark of Apple Inc. Use of the Apple CarPlay logo means that a vehicle user interface meets Apple performance standards. Apple is not responsible for the operation of this vehicle or its compliance with safety and regulatory standards. Please note that the use of this product with iPhone, iPod, or iPad may affect wireless performance. Apple CarPlay requires a compatible device, mobile data, network reception & GPS signal. Mobile usage at user's cost. Please visit [apple.com/au/ios/carplay/](http://apple.com/au/ios/carplay/) for device compatibility.

Apple, iPhone, iPod, iPad and Siri are trademarks of Apple Inc., registered in the U.S. and other countries. Apple CarPlay is a trademark of Apple Inc.

Android, Android Auto, Google Assistant, and Google are trademarks of Google Inc.

Availability of Android Auto may vary depending upon your country and phone model. To wirelessly use Android Auto on your car display, you need a compatible Android smartphone with an active data plan. You can check which smartphones are compatible [android.com/auto](http://android.com/auto).

While this product is compatible for use with Bluetooth, it is not made or endorsed by Bluetooth SIG inc.

DAB+ and all related marks and logos are trademarks of WorldDAB. All rights reserved.

Other trademarks and trade names are those of their respective owners.

Some vehicle features may not be retained, or may function differently. For more information visit [aerpro.com](http://aerpro.com). iPhones, Android smartphones or any other accessories shown or listed are not supplied and must be purchased separately.

Design and specifications are subject to change without notice.

25-09-2024